

Dell™ S320/S320wi Projector

User's Guide

Notes, Cautions, and Warnings



NOTE: A NOTE indicates important information that helps you make better use of your projector



CAUTION: A CAUTION indicates potential damage to hardware or loss of data if instructions are not followed.



WARNING: A WARNING indicates a potential for property damage, personal injury, or death.

Information in this document is subject to change without notice.

© 2012 Dell Inc. All rights reserved.

Reproduction of these materials in any manner whatsoever without the written permission of Dell Inc. is strictly forbidden.

Trademarks used in this text: *Dell* and the *DELL* logo are trademarks of Dell Inc.; *DLP* and *DLP* logo are trademarks of TEXAS INSTRUMENTS INCORPORATED; *Microsoft* and *Windows* are either trademarks or registered trademarks of Microsoft Corporation in the United States and/or other countries.

Other trademarks and trade names may be used in this document to refer to either the entities claiming the marks and names or their products. Dell Inc. disclaims any proprietary interest in trademarks and trade names other than its own.

Model S320/S320wi

September 2012 Rev. A00

Contents

1	Your Dell Projector	7
	About Your Projector	10
	About Your Interactive Pen	11
2	Connecting Your Projector	13
	Installing the Optional Wireless Module Kit	14
	Installing the Optional Interactive Module Kit	15
	Installing the Optional RJ45 Kit	16
	Connecting to a Computer	17
	Connecting a Computer Using a VGA Cable	17
	Monitor Loop-Through Connection Using VGA Cables	18
	Connecting a Computer Using a RS232 cable	19
	Connecting a Computer by USB Cable	20
	Connecting a Computer Using Wireless Dongle (Optional)	21
	Connecting a DVD Player	22
	Connecting a DVD Player Using an S-Video Cable	22
	Connecting a DVD Player Using a Composite Video Cable	23
	Connecting a DVD Player Using a Component Video Cable	24
	Connecting a DVD Player Using a HDMI Cable	25
	Connecting to Local Area Network	26
	To project an image and control the projector that is connected to a network through a RJ45 cable.	26

Connection With Commercial RS232 Control Box	27
Connecting With Your Interactive Pen	28
3 Using Your Projector	30
Turning Your Projector On	30
Turning Your Projector Off	30
Adjusting the Projected Image	31
Raising the Projector Height	31
Lowering the Projector Height	31
Adjusting the Projector Focus	32
Adjusting Projection Image Size	33
Using the Control Panel	35
Using the Remote Control	37
Using the Interactive Pen	40
OSD warning messages - low battery	41
Combinations of buttons	41
Using the Wrist Strap	42
Installing the Remote Control Batteries	43
Charging the Interactive Pen Battery	44
Docking Charger Introduction (Optional)	45
Charging the Interactive Pen Battery by Docking Charger	47
Operating Range with Remote Control	49
Operating Range with Interactive Pen	50
Using the On-Screen Display	51
INPUT SOURCE	51

AUTO ADJUST	52
BRIGHTNESS/CONTRAST	53
VIDEO MODE	53
VOLUME	54
AUDIO INPUT	54
ADVANCED SETTINGS	55
LANGUAGE	72
HELP	73
Wireless Networking Installation	74
Enable Wireless on the Projector	75
Install the Wireless Application Software on Your Computer	76
Launch the Wireless Application	80
Presentation to Go (PtG) Installation	83
PtG Viewer	84
Photo Viewer	84
PtG/Photo Function Introduction	85
PtG Overview	85
Photo Overview	86
Buttons Introduction	86
Install the PtG Converter Application Software on Your Computer	87
Using the PtG Converter	87
Audio Projection Installation	89
Enable Wireless or LAN on the Projector	91
Install the Wireless Application Software on Your Computer	92
Launch the Wireless Application	93
Login	94
Managing the Projector From Web Management (for Wireless Network)	95

	Configuring the Network Setting	95
	Accessing Web Management	95
	Managing the Projector From Web Management (Network RJ45 Kit is Optional for S320)	110
	Configuring the Network Setting	110
	Accessing Web Management	110
	Managing Properties	111
	Make Application Token	125
4	Troubleshooting Your Projector	126
	Troubleshooting your Interactive Pen	130
	Guiding Signals	132
	Interactive Pen LED Guiding Signals	133
	Changing the Lamp	134
5	Specifications	136
6	Contacting Dell	144
	Contacting eInstruction	145
	Contacting Crestron	146
7	Appendix: Glossary	147

Your Dell Projector

Your projector comes with all the items shown below. Ensure that you have all the items, and contact Dell if anything is missing.

S320 Standard Package Contents

Power cable

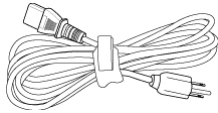

1.8 m VGA cable (VGA to VGA)

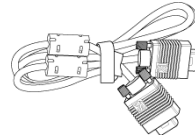

AAA Batteries (2)



Remote control



CD User's Guide and Documentation

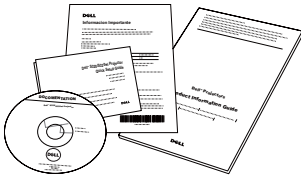

Dell Interactive wireless dongle (Optional)

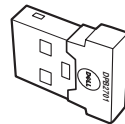

S320wi Standard Package Contents

Power cable

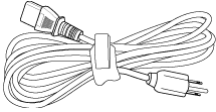

1.8 m VGA cable (VGA to VGA)

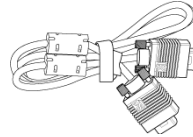

AAA Batteries (2)



Remote control



CD User's Guide and Documentation

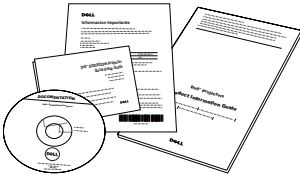

Interactive Pen

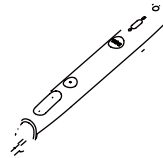

Wrist strap



Nib (10 spare pen nib)



Interwrite Workspace CD



2 m Mini USB cable (USB-A to Mini USB-B)

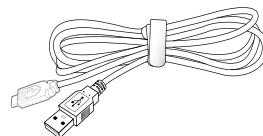

S320wi Standard Package Contents

5 m Mini USB cable (USB-A to Mini USB-B)

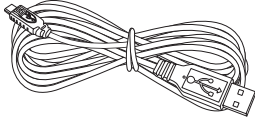

USB cable (USB-A to USB-B)

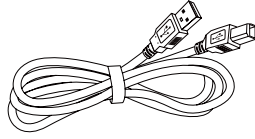

Dell Interactive wireless dongle
(Optional)

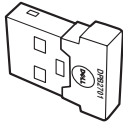

About Your Projector

Top View

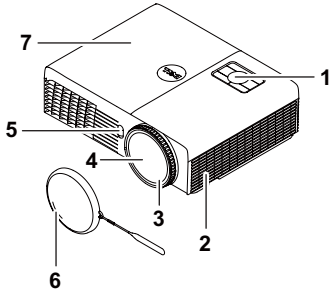

Bottom View

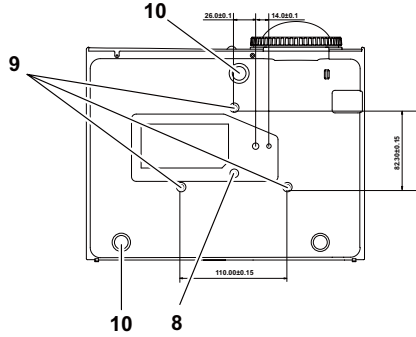

1	Control panel
2	5W speaker
3	Focus ring
4	Lens
5	IR receivers
6	Lens cap
7	Lamp cover
8	Mounting holes for wall mount: Screw hole M3 x 6.5 mm depth. Recommended torque <8 kgf-cm
9	Mounting hole for tripod: Insert nut 1/4"×20 UNC
10	Tilt adjustment wheel

About Your Interactive Pen

Top View

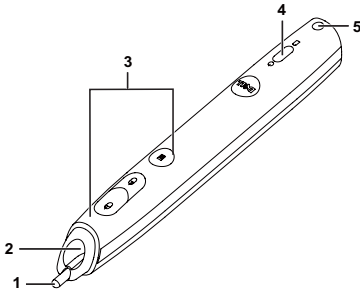

Bottom View

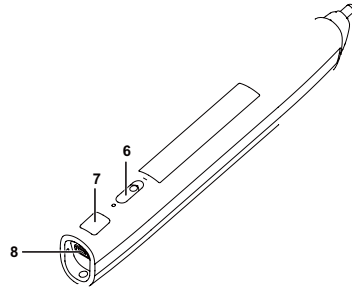

1	Replaceable nib
2	Lens
3	Control buttons
4	LED indicators
5	Wrist strap holder
6	Power switch
7	Firmware upgrade connector
8	Mini USB charge connector



NOTE: Optional (can be bought separately), or comes with S320wi only.



CAUTION: Safety Instructions

- 1 Do not use the projector near appliances that generate a lot of heat.
- 2 Do not use the projector in areas where there is an excessive amount of dust. The dust may cause the system to fail and the projector will automatically shutdown.
- 3 Ensure that the projector is mounted in a well-ventilated area.
- 4 Do not block the ventilation slots and openings on the projector.
- 5 Ensure the projector operates between ambient temperatures (5 °C to 35 °C).
- 6 Do not try to touch the ventilation outlet as it can become very hot after the projector has been turned on or immediately after it is turned off.
- 7 Do not look into the lens while the projector is on as it may cause injury to your eyes.

- 8 Do not place any objects near or in front of the projector or cover its lens while the projector is on as the heat may cause the object to melt or burn.
- 9 Do not use the wireless projector near cardiac pacemakers.
- 10 Do not use the wireless projector near medical equipment.
- 11 Do not use the wireless projector near microwave ovens.



NOTE:

- Do not attempt to wall mount the projector by yourself. It should be installed by a qualified technician.
- Recommended Projector Wall Mount Kit (P/N: 4TVT8/V3RTH). For more information, see the Dell Support website at support.dell.com.
- For more information, see the *Safety Information* that shipped with your projector.
- The S320/S320wi projector can only be used indoors.

2

Connecting Your Projector

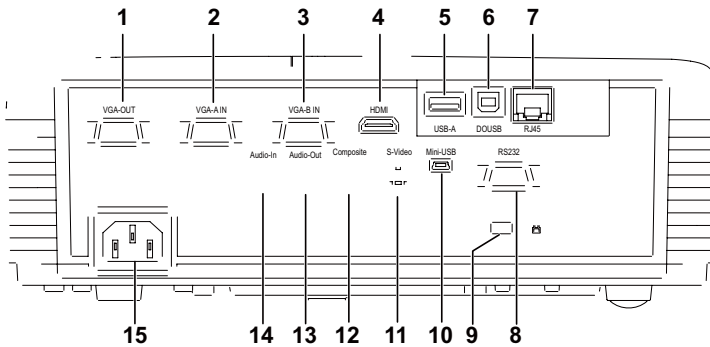

1	VGA output (monitor loop through) connector	9	Security cable slot
2	VGA-A input (D-sub) connector	10	Mini USB (Mini Type B) connector for remote mouse, Interactive function, and firmware upgrade
3	VGA-B input (D-sub) connector	11	S-Video connector
4	HDMI connector	12	Composite Video connector
5	USB Type A connector for USB Viewer (embedded for S320wi)	13	Audio output connector
6	USB Type B connector for USB Display (embedded for S320wi)	14	Audio input connector
7	RJ45 connector (embedded for S320wi)	15	Power cord connector
8	RS232 connector		



CAUTION: Before you begin any of the procedures in this section, follow the Safety Instructions as described on page 11.

Installing the Optional Wireless Module Kit

Your projector must be installed with the wireless module kit if you want to use the wireless networking option. Refer to "Wireless Networking Installation" on page 74. The wireless module kit is not shipped with your S320 projector. You can purchase it on the Dell website at www.dell.com.

 **NOTE:** Wireless module kit embedded for S320wi.

The installation steps are as below:

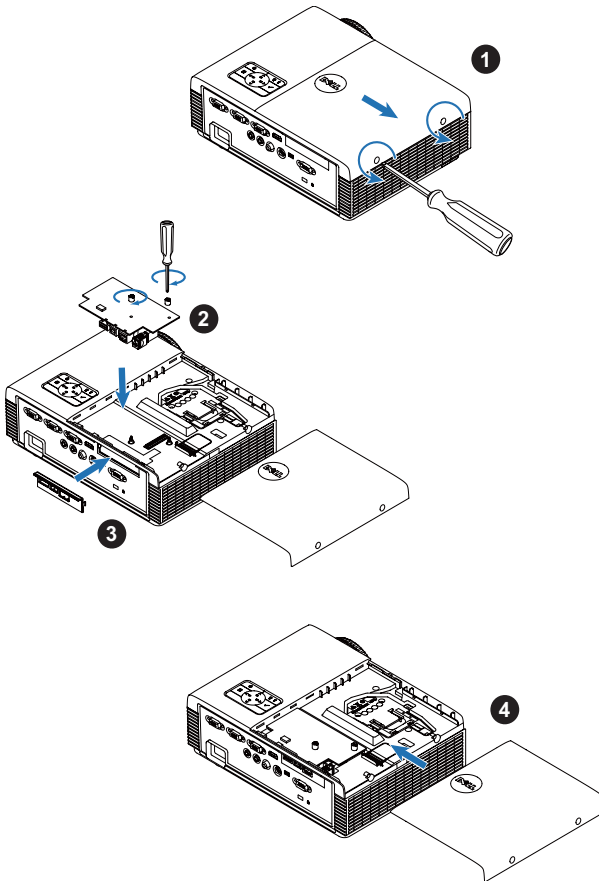

Installing the Optional Interactive Module Kit

Your projector must be installed with Interactive module kit if you want to use the Interactive feature. The Interactive module kit is not shipped with your S320 projector. You can purchase it on the Dell website at www.dell.com.

 **NOTE:** Interactive module kit embedded for S320wi.

The installation steps are as below:

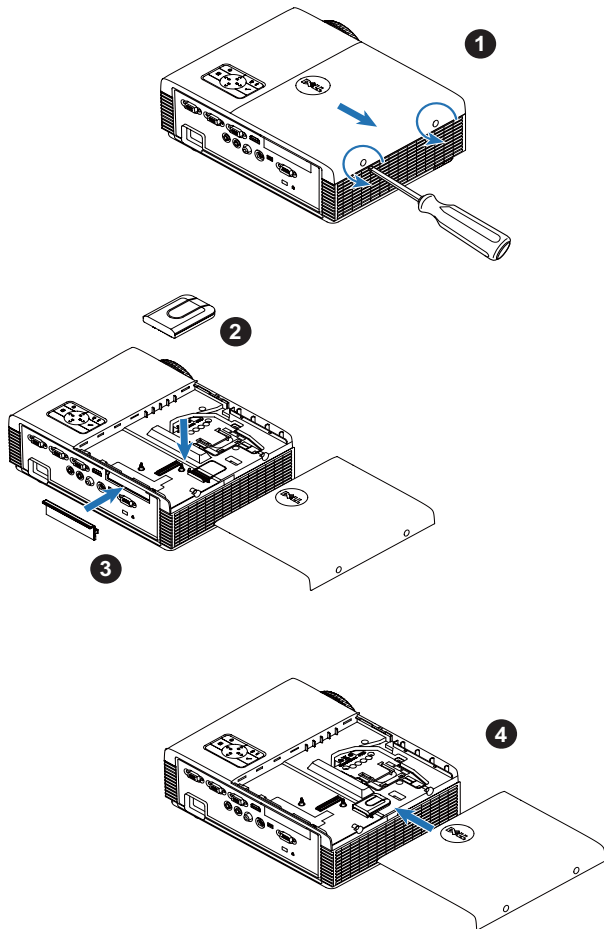

Installing the Optional RJ45 Kit

Your projector must be installed with RJ45 kit if you want to use the network option. The RJ45 kit is not shipped with your S320 projector. You can purchase it on the Dell website at www.dell.com.

 **NOTE:** RJ45 is embedded in the S320wi.

The installation steps are as below:

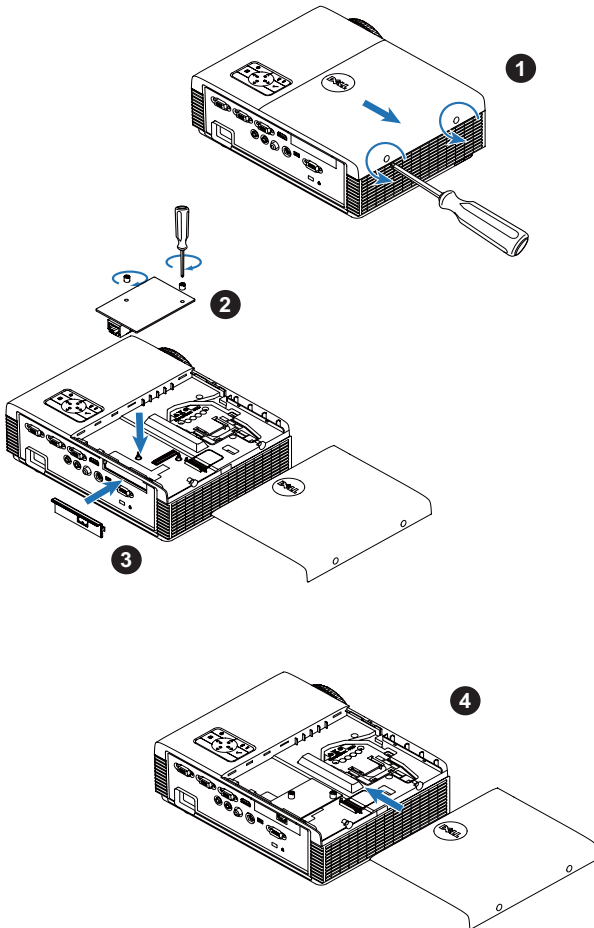

Connecting to a Computer

Connecting a Computer Using a VGA Cable

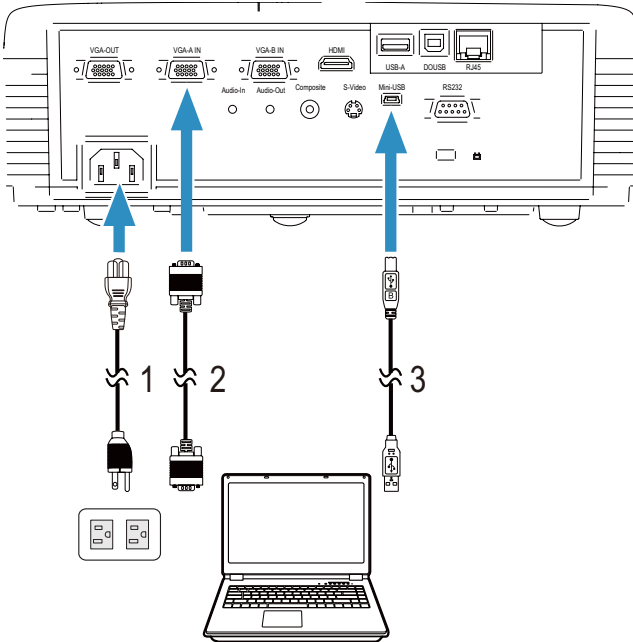

1	Power cord
2	VGA to VGA cable
3	USB-A to Mini USB-B cable



NOTE: The Mini USB cable must be connected if you want to use the Page Up and Page Down features on the remote control.

Monitor Loop-Through Connection Using VGA Cables

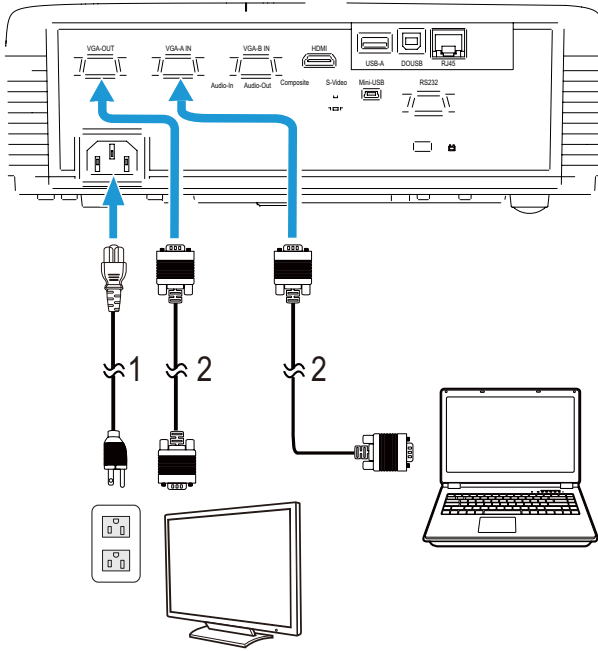

1	Power cord
2	VGA to VGA cable



NOTE: Only one VGA cable is shipped with your projector. An additional VGA cable can be purchased on the Dell website at www.dell.com.

Connecting a Computer Using an RS232 cable

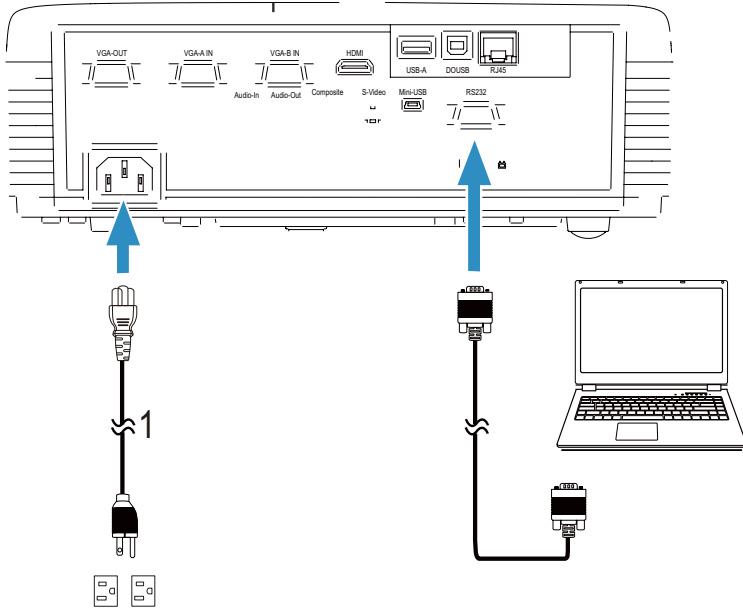

1	Power cord
2	RS232 (9-pin D-sub female to female pin2-3 swap) cable



NOTE: The RS232 (9-pin D-sub female to female pin2-3 swap) cable is not shipped with your projector. Consult a professional installer for the cable and RS232 remote control software.

Connecting a Computer by USB Cable

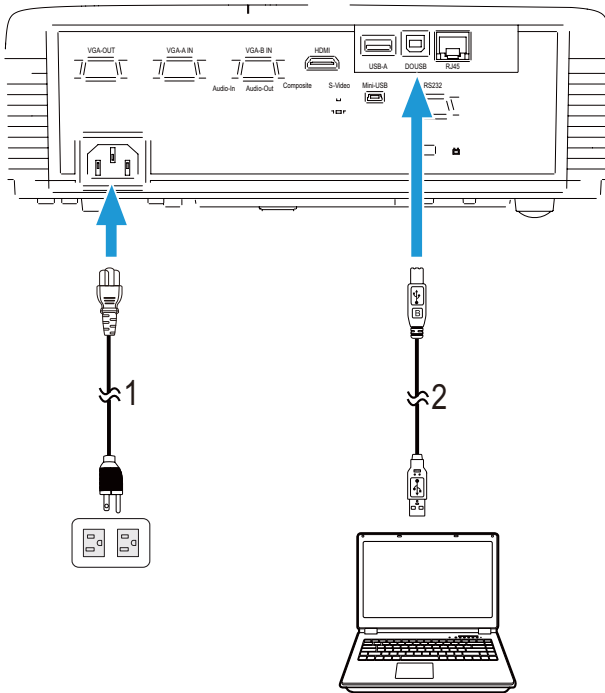

1	Power cord
2	USB-A to USB-B cable



NOTE: Plug and Play. Only one USB cable is shipped with your projector. An additional USB cable can be purchased on the Dell website at www.dell.com.

Connecting a Computer Using Wireless Dongle (Optional)

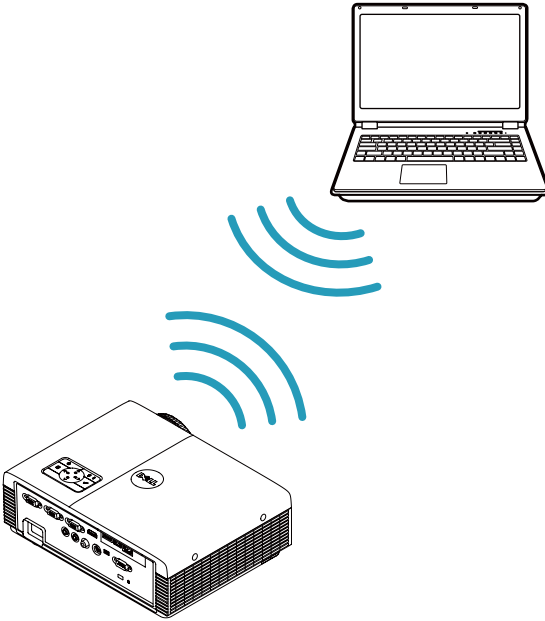

- ✎ **NOTE:** A USB wireless dongle is embedded in the Dell S320wi.
- ✎ **NOTE:** Wireless functionality is an optional feature on the Dell S320. If you would like to include wireless functionality, please install a wireless module and a USB wireless dongle into your Dell S320. See step-by-step installation guide on page 13. Wireless modules and USB wireless dongles are available and sold separately on www.dell.com.
- ✎ **NOTE:** Your computer should be equipped with a wireless connector and properly configured to detect another wireless connection. Refer to your computer's documentation on how to configure a wireless connection.
- ✎ **NOTE:** Your projector must have the wireless dongle installed if you want to use wireless networking. Refer to "Wireless Networking Installation" on page 74.

Connecting a DVD Player

Connecting a DVD Player Using an S-Video Cable

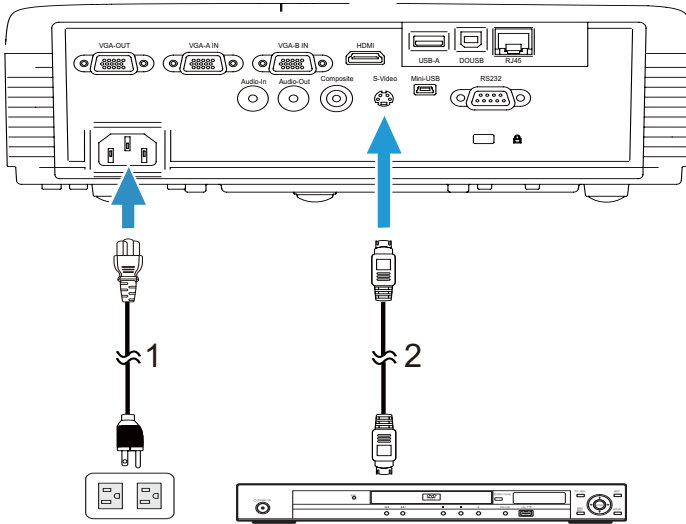

1	Power cord
2	S-Video cable

NOTE: The S-Video cable is not shipped with your projector. You can purchase the S-Video extension (50 ft/100 ft) cable on the Dell website at www.dell.com.

Connecting a DVD Player Using a Composite Video Cable

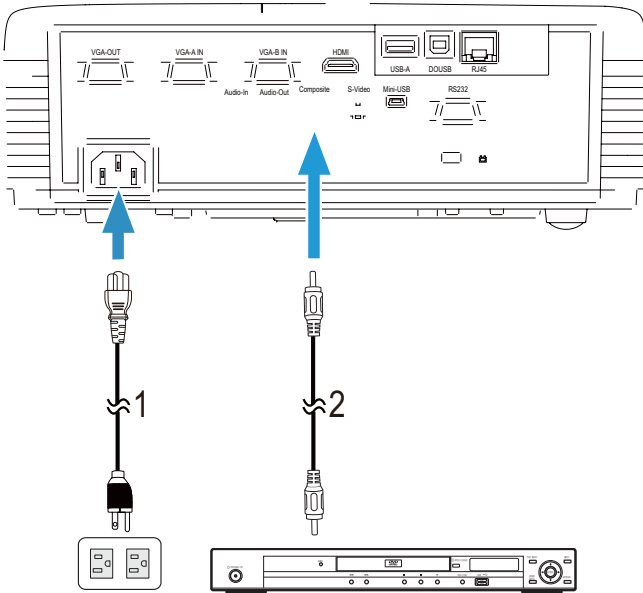

1	Power cord
2	Composite Video cable



NOTE: The Composite Video cable is not shipped with your projector. You can purchase the Composite Video Extension (50 ft/100 ft) cable on the Dell website at www.dell.com.

Connecting a DVD Player Using a Component Video Cable

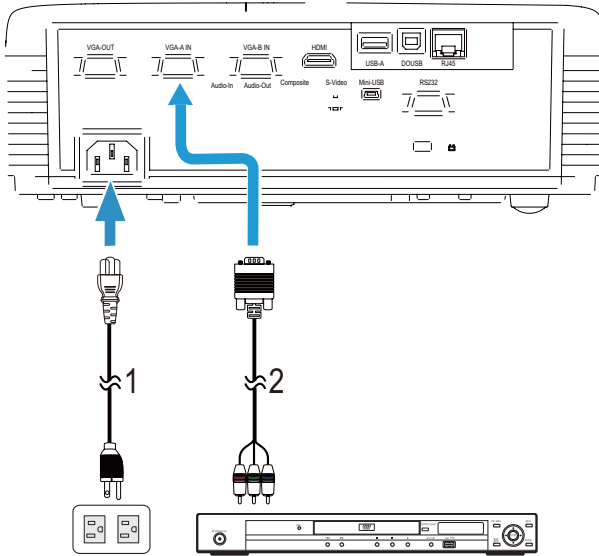

1	Power cord
2	VGA to Component Video cable

NOTE: The VGA to Component Video cable is not shipped with your projector. You can purchase the VGA to Component Video Extension (50 ft/100 ft) cable on the Dell website at www.dell.com.

Connecting a DVD Player Using a HDMI Cable

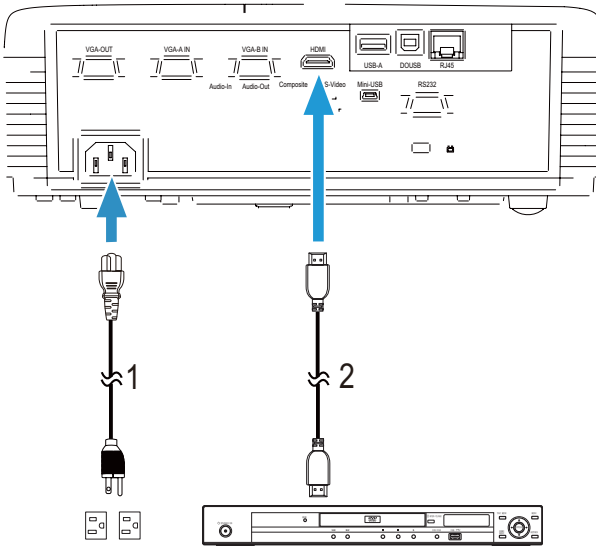

1	Power cord
2	HDMI cable



NOTE: The HDMI cable is not shipped with your projector. You can purchase the HDMI cable on the Dell website at www.dell.com.

Connecting to Local Area Network

To project an image and control the projector that is connected to a network through a RJ45 cable.

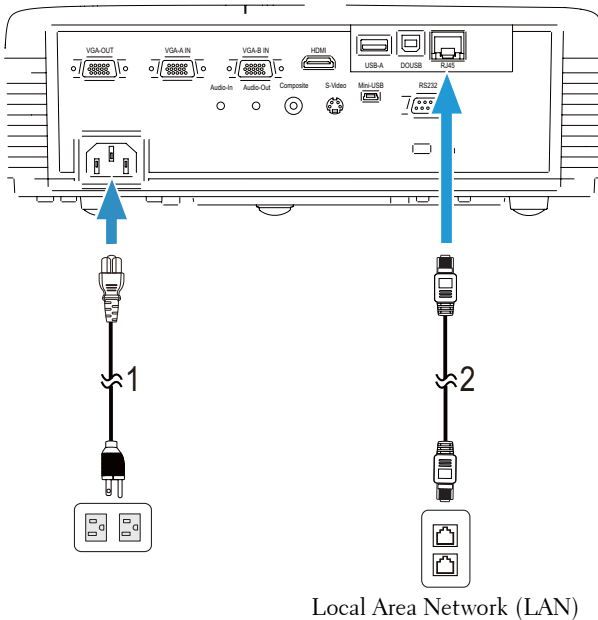

1	Power cord
2	RJ45 cable

NOTE: The RJ45 cable is not shipped with your projector. You can purchase the RJ45 cable on the Dell website at www.dell.com.

NOTE: LAN module kit is not shipped with your S320 projector. If you want to use the network option, see "Installing the Optional RJ45 Kit" on page 16. You can purchase it on the Dell website at www.dell.com.

Connection With Commercial RS232 Control Box

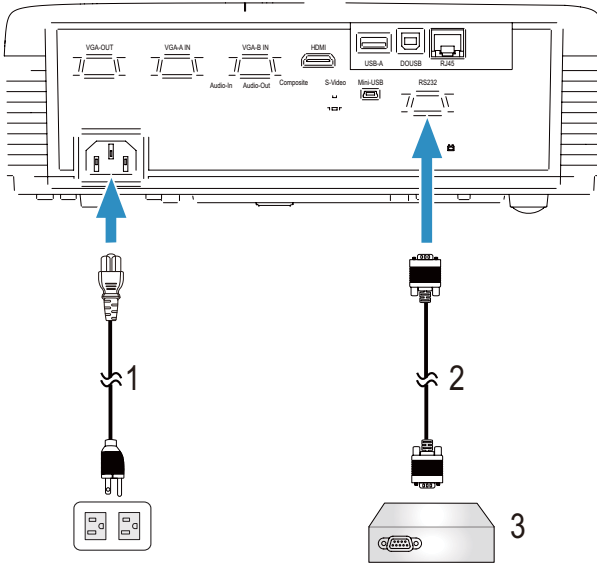

1	Power cord
2	RS232 (9-pin D-sub female to female pin2-3 swap) cable
3	Commercial RS232 control box



NOTE: The RS232 (9-pin D-sub female to female pin2-3 swap) cable is not shipped with your projector. Consult a professional technician to obtain the cable.

Connecting With Your Interactive Pen

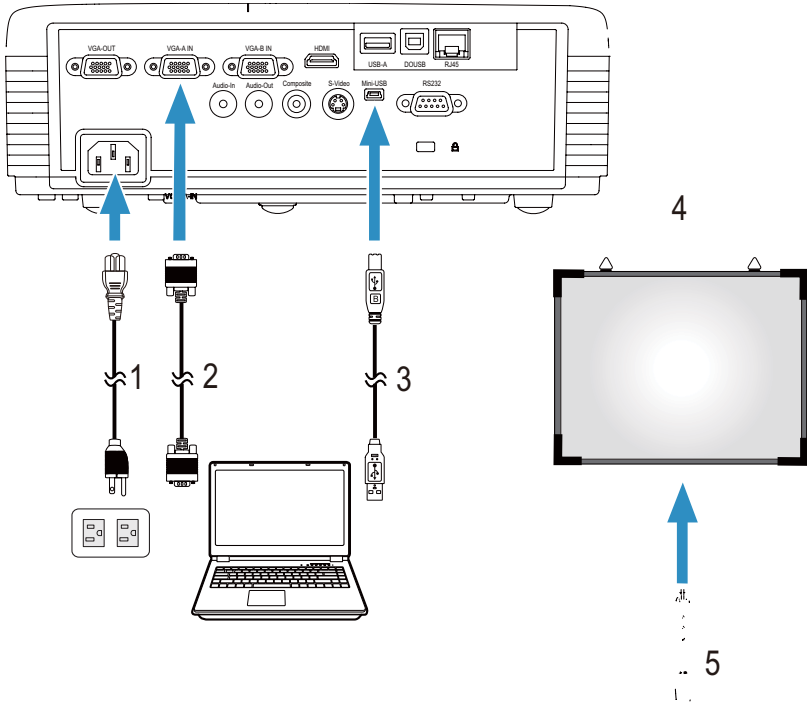

1	Power cord
2	VGA to VGA cable
3	USB-A to Mini USB-B cable
4	Projection screen
5	Interactive Pen



NOTE: Interactive module kit is not shipped with your S320 projector. If you want to use the Interactive feature, see "Installing the Optional Interactive Module Kit" on page 15. You can purchase it on the Dell website at www.dell.com.



NOTE:

- 1 Interactivity is supported only in the following input modes: VGA and HDMI from a PC, and Wireless Display, USB Display, and LAN Display.
- 2 To enable Interactive Pen, the 2nd connection between computer and projector is required. There are four options available for your computer and projector connections:
 - a use a Mini USB cable or Dell Interactive wireless dongle (optional)
Dell Interactive wireless dongle is not shipped with your S320 or S320wi projector. If you want to use Dell Interactive wireless dongle to connect the computer and the projector, you can purchase it on the Dell website at www.dell.com.
 - b use a LAN cable (need to install the Dell Wireless Application Software)
 - c use WLAN (need to install the Dell Wireless Application Software)If you use a LAN or WLAN connection, ensure that Wireless/LAN is turned on first.
- 3 If the distance between your computer/laptop and projector is over 5 meters, a USB hub is recommended for your installation.

Using Your Projector

Turning Your Projector On

 **NOTE:** Turn on the projector before you turn on the source (computer, DVD player, etc.). The **Power** button light blinks blue until pressed.

- 1 Remove the lens cap.
- 2 Connect the power cord and appropriate signal cables to the projector. For information about connecting the projector, see "Connecting Your Projector" on page 13.
- 3 Press the **Power** button (see "Using the Control Panel" on page 35 to locate the **Power** button).
- 4 Turn on your source (computer, DVD player, etc.)
- 5 Connect your source to the projector using the appropriate cable. See "Connecting Your Projector" on page 13 for instructions to connect your source to the projector.
- 6 By default, the input source of the projector is set to VGA-A. Change the input source of the projector if necessary.
- 7 If you have multiple sources connected to the projector, press the **Source** button on the remote control or control panel to select the desired source. See "Using the Control Panel" on page 35 and "Using the Remote Control" on page 37 to locate the **Source** button.

Turning Your Projector Off

 **CAUTION:** Unplug the projector after properly shutting down as explained in the following procedure.

- 1 Press the **Power** button. Follow the instruction displayed on screen to properly turn off the projector.

 **NOTE:** The "**Press Power Button to Turn off Projector**" message will appear on the screen. The message disappears after 5 seconds or you can press the **Menu** button to clear it.

- 2 Press the **Power** button again. The cooling fans continue to operate for 120 seconds.

3 To power off the projector quickly, press the Power button and hold for 1 second while the projector's cooling fans are still running.

NOTE: Before you turn on the projector again, wait for 60 seconds to allow the internal temperature to stabilize.

4 Disconnect the power cord from the electrical outlet and the projector.

Adjusting the Projected Image

Raising the Projector Height

1 Raise the projector to the desired display angle, and use the front tilt adjustment wheel to fine-tune the display angle.

2 Use the two tilt adjustment wheels to fine-tune the display angle.

Lowering the Projector Height

1 Lower the projector, and use the front tilt adjustment wheels to fine-tune the display angle.

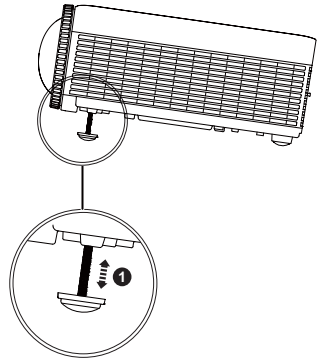
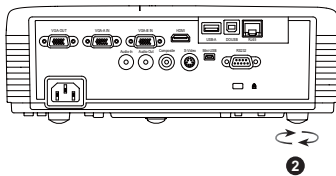
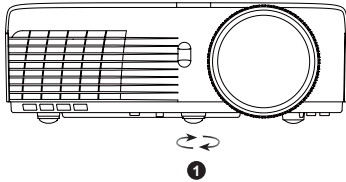

1	Front tilt adjustment wheel (Angle of tilt: 0 to 4 degree)
2	1x Rear tilt adjustment wheel

Adjusting the Projector Focus

 **CAUTION:** To avoid damaging the projector, ensure that the front tilt adjustment wheel is fully retracted before moving the projector or placing the projector in its carrying case.

 **NOTE:** The carrying case is not shipped with your projector. You can purchase the carrying case (P/N: 8R3VM) on the Dell website at www.dell.com.

1 Rotate the focus tab until the image is clear. The projector focuses at distances ranging between 1.31 ft to 12.5 ft (0.4 m to 3.82 m).

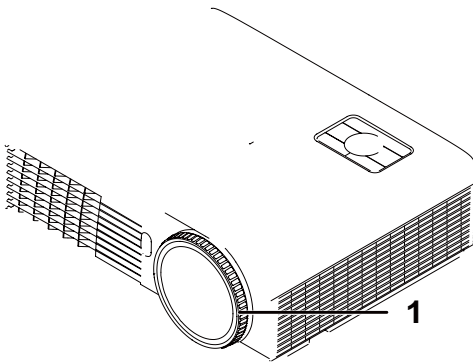

1	Focus ring
---	------------

Adjusting Projection Image Size

S320/S320wi

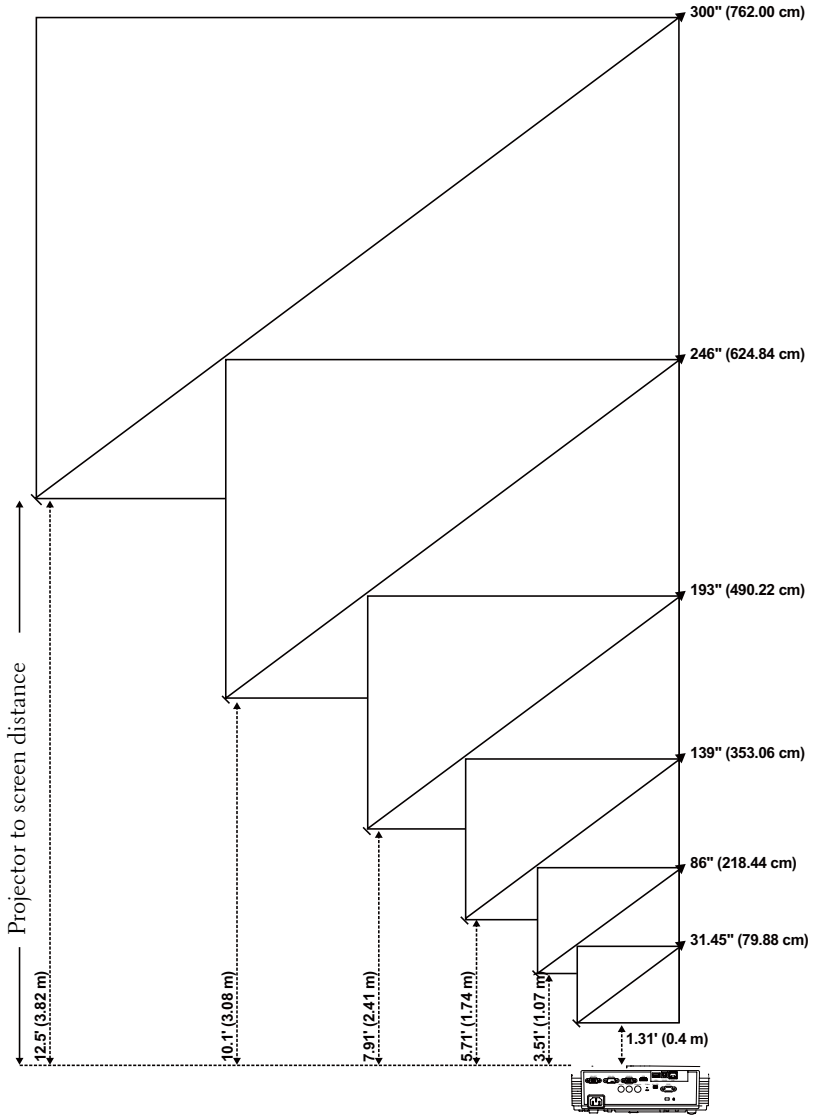

S320/S320wi

Desired Distance (m) <A>	Screen size		Top
	(Min zoom)		
	Diagonal (inch) 	W (cm) x H (cm)	From base to top of image (cm) <C>
0.4	31.45	65 x 49	56
1.07	86	174 x 130	150
1.74	139	283 x 212	244
2.41	193	392 x 294	338
3.08	246	501 x 376	432
3.82	300	610 x 457	526



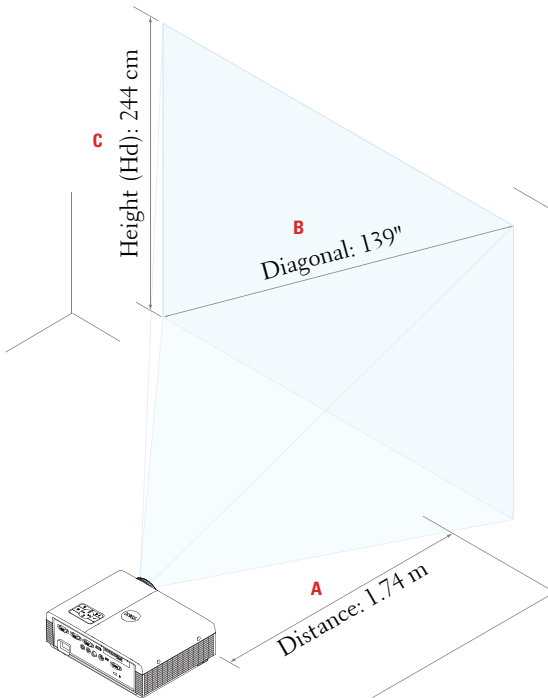

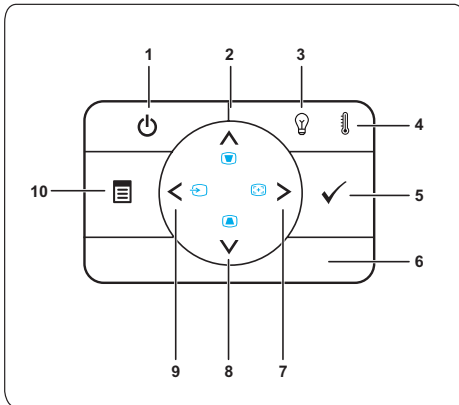

* This graph is for user reference only.
* Offset Ratio: 115±5%



Using the Control Panel









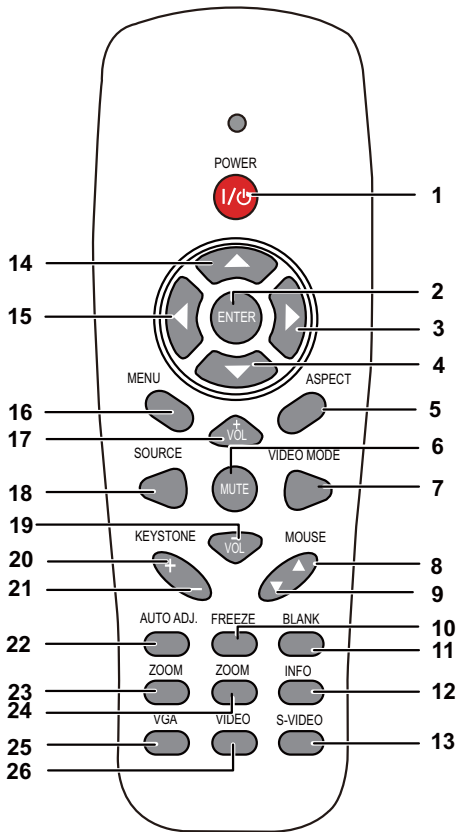





1 Power	Turns the projector on or off. For more information, see "Turning Your Projector On" on page 30 and "Turning Your Projector Off" on page 30.
2 Up  / Keystone adjustment	Press to navigate through the On-Screen Display (OSD) Menu items. Press to adjust image distortion caused by tilting the projector (+37/-40 degrees).
3 LAMP warning light	If the LAMP amber indicator is on or blinking, one of the following problems could be occurring: <ul style="list-style-type: none"> • Lamp is reaching its end of usable life • Lamp module is not properly installed • Lamp driver failure • Color wheel failure For more information, see "Troubleshooting Your Projector" on page 126 and "Guiding Signals" on page 132.

4	TEMP warning light	<p>If the TEMP amber indicator is on or blinking, one of the following problems could be occurring:</p> <ul style="list-style-type: none"> • Internal temperature of the projector is too high • Color wheel failure <p>For more information, see "Troubleshooting Your Projector" on page 126 and "Guiding Signals" on page 132.</p>
5	Enter 	Press to confirm the selection item.
6	IR Receiver	Point the remote control towards the IR receiver and press a button.
7	Right  / Auto Adjust	<p>Press to navigate through the On-Screen Display (OSD) Menu items.</p> <p>Press to synchronize the projector to the input source.</p> <p> NOTE: Auto Adjust does not operate if the on-screen display (OSD) is displayed.</p>
8	Down  / Keystone adjustment	<p>Press to navigate through the On-Screen Display (OSD) Menu items.</p> <p>Press to adjust image distortion caused by tilting the projector (+37/-40 degrees).</p>
9	Left  / Source	<p>Press to navigate through the On-Screen Display (OSD) Menu items.</p> <p>Press to toggle through Analog RGB, Composite, Component (YPbPr via VGA), HDMI, and S-Video sources when multiple sources are connected to the projector.</p>
10	Menu 	Press to activate the OSD. Use the directional keys and the Menu button to navigate through the OSD.

Using the Remote Control



1	Power 	Turns the projector on or off. For more information, see "Turning Your Projector On" on page 30 and "Turning Your Projector Off" on page 30.
2	Enter 	Press to confirm the selection.
3	Right 	Press to navigate through the On-Screen Display (OSD) Menu items.
4	Down 	Press to navigate through the On-Screen Display (OSD) Menu items.

5	Aspect Ratio	Press to change the aspect ratio of a displayed image.
6	Mute 	Press to mute or un-mute the projector speaker.
7	Video mode	The projector has preset configurations that are optimized for displaying data (presentation slides) or video (movies, games, etc.). Press the Video Mode button to toggle between Presentation mode , Bright mode , Movie mode , sRGB , or Custom mode . Pressing the Video Mode button once will show the current display mode. Pressing the Video Mode button again will switch between modes.
8	Mouse up 	Press to move to the previous page.  NOTE: The Mini USB cable must be connected if you want to use the Page Up feature.
9	Mouse down 	Press to move to the next page.  NOTE: The Mini USB cable must be connected if you want to use the Page Down feature.
10	Freeze	Press to pause the screen image, then press "Freeze" again to unfreeze the image.
11	Blank screen	Press to hide/unhide the image.
12	Information	Press to provide projector native resolution information.
13	S-Video	Press to choose S-Video source.
14	Up 	Press to navigate through the On-Screen Display (OSD) Menu items.
15	Left 	Press to navigate through the On-Screen Display (OSD) Menu items.
16	Menu	Press to activate the OSD.
17	Volume up 	Press to increase the volume.
18	Source	Press to switch between Analog RGB, Composite, Component (YPbPr, via VGA), HDMI, and S-Video source.

19	Volume down 	Press to decrease the volume.
20	Keystone adjustment +	Press to adjust image distortion caused by tilting the projector (+37/-40 degrees).
21	Keystone adjustment -	Press to adjust image distortion caused by tilting the projector (+37/-40 degrees).
22	Auto Adjust	Press to synchronize the projector with the input source. Auto adjust does not operate if the OSD is displayed.
23	Zoom +	Press to increase the image.
24	Zoom -	Press to decrease the image.
25	VGA	Press to choose VGA source.
26	Video	Press to choose Composite Video source.

Using the Interactive Pen

Top View

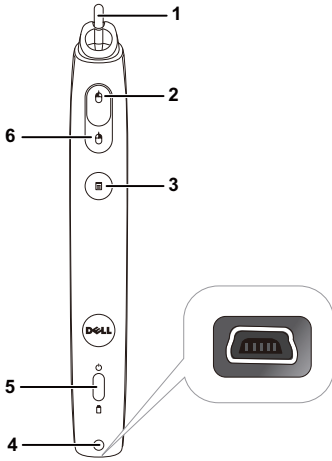

Bottom View

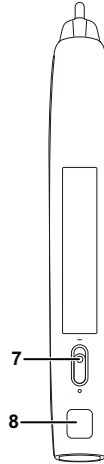



1 Replaceable nib

Press the nib to draw or write. When the nib is engaged, it works like left clicking your mouse to draw or write.

 **NOTE:**

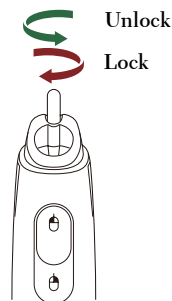
- If the nib is engaged, the Pen will switch to Draw mode and the button function will be temporarily disabled.
- When the nib wears out, change the nib head as shown below.



2	Left	This button acts like the left click button of a mouse.
3	Function	Functions available are listed in the OSD Menu "Set function" (see page 70).  NOTE: Double-clicking the Function button will act as Undo, if supported by the software.
4	Mini USB charge connector	Allow you use Mini USB cable to charge. See "Charging the Interactive Pen Battery" on page 44.
5	LED indicators	Two LED indicators are available: Green and Amber (see "Interactive Pen LED Guiding Signals" on page 133).
6	Right	This button acts like the right-click button of a mouse.
7	Power switch	Turns the Interactive Pen on or off.
8	Firmware upgrade connector	For Interactive Pen and RF board firmware upgrade.

OSD warning messages - low battery

- The Low Battery warning message pops up when the battery voltage is lower than 2 V. At this condition, the pen can still work about 1~2 hours.
- The pen will be disabled when the battery voltage is lower than 1.8 V.

Combinations of buttons

- **Left + Function:** The Pen Information menu appears on the screen.
- **Hold Function:** Hold the Function button for 2 seconds and the Function menu will appear on the screen. Use Left/Right to move up/down and use Function to enter/apply.
- When Toggle is selected in the Set Function menu, press the Function button to select Normal/Draw/Stable mode.



NOTE: Interactive pen cannot support Windows Mouse property function "Switch primary and secondary buttons".

Using the Wrist Strap

Please use the wrist strap as a safety precaution in case of loss of grip on the Interactive Pen, and prevent damage to the Interactive Pen, surrounding objects, or injury to other people.

- 1 Feed the cord on the wrist strap through the connector holder.

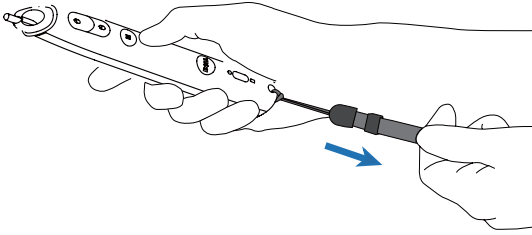

- 2 Wear the wrist strap on your wrist.

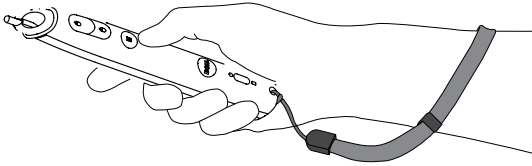

Installing the Remote Control Batteries

 **NOTE:** Remove the batteries from the remote control when not in use.

1 Press the tab to lift the battery compartment cover.

1



2 Check the polarity (+/-) marking on the batteries.

2

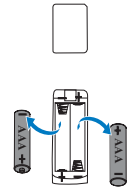

3 Insert the batteries and align their polarity correctly according to the marking in the battery compartment.

3

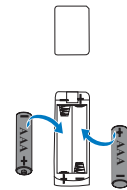

 **NOTE:** Avoid mixing different types of batteries or using new and old batteries together.

4 Slip the battery cover back.

4



Charging the Interactive Pen Battery

When the Interactive Pen amber battery light starts to blink, its internal battery is low (If the battery is fully discharged, you will not be able to turn the Interactive Pen on by pressing its nib, left, right or set function buttons).

To charge the battery, connect a mini USB cable between the Interactive Pen and your computer or laptop (If connecting to computer or laptop, make sure the computer or laptop is powered on). The battery light will stay on while the battery is charging and turn off when the battery is fully charged.

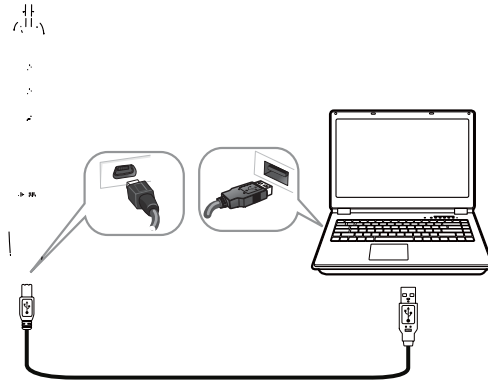

When charging is finished, you can unplug the mini USB cable (or keep the cable connected and use the Interactive Pen while it's charging).

 **NOTE:** For first time use, it takes at least 4-5 hours to fully charge the battery. A fully charged battery will allow 25 hours of non-stop use or up to 4 weeks in standby.

 **CAUTION:** The lithium battery is only rechargeable and is not user replaceable or serviceable. If your Interactive Pen cannot charge, contact Dell (See "Contacting Dell" on page 144).

 **CAUTION:** Always use the included mini USB cable and your computer (or use the Docking Charger) to charge the Interactive Pen. The Docking Charger is not shipped with your projector. You can purchase it on the Dell website at www.dell.com.

Docking Charger Introduction (Optional)

Front View

Back View

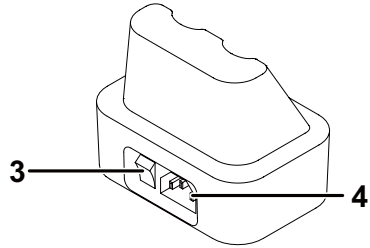
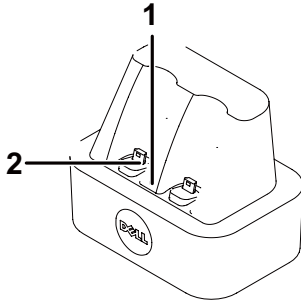

1	Power LED light
2	Mini USB connector
3	Power switch
4	Power cord connector



NOTE: The Docking Charger is not shipped with your S320 or S320wi projector. You can purchase the Docking Charger on the Dell website at www.dell.com.

LED Indicator on Docking Charger

Green LED Solid On	When the docking charger is switched on, the Green LED will turn solid ON.
Green LED Off	The Green LED will turn Off when the docking charger is switched off.

LED Indicator on Interactive Pen

Amber LED Solid On	The Amber LED will turn solid ON during the charge process.
Amber LED Off	Once battery is fully charged, the LED will turn OFF indicating "Charge Complete".
Amber LED Flashing	If the Amber LED starts FLASHING (0.4 sec ON, 0.6 sec OFF, 1 sec per flashing cycle), it indicates no charging takes place. Charger error or bad battery is identified.

Docking Charger Specification (Power Supply)

Model:	Interactive Projector Pen Charging Station
Power Supply:	Input AC 100-240 V, 50-60 Hz, 0.2 A Output DC 5 V/1 A
Maximum temperature:	40 °C

Charging the Interactive Pen Battery by Docking Charger

When the Interactive Pen amber battery light starts to blink, its internal battery is low (If the battery is fully discharged, you won't be able to turn the Interactive Pen on by pressing its nib, left, right or set function buttons).

To charge the battery, you can follow the following steps:

1 Connect the power cable to the wall outlet.

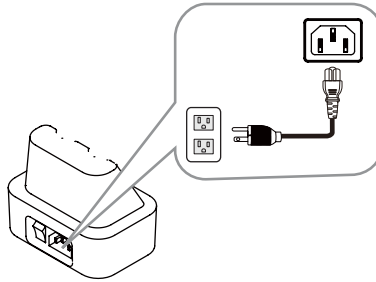

2 Plug the Interactive Pen into the Mini USB port of the docking charger.

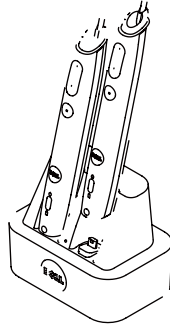

3 Turn On the power switch on the docking charger.

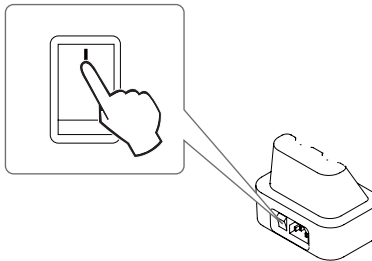

 **NOTE:** During the charging process, Interactive Pen amber battery light will be lit all the time until the charging process is complete.

 **NOTE:** For first time use, it takes at least 4-5 hours to fully charge the battery. A fully charged battery will allow up to 25 hours of non-stop use or up to 4 weeks in standby.

 **CAUTION:** If your docking charger cannot charge, contact DELL.

Operating Range with Remote Control

Operating range	
Angle	$\pm 20^\circ$
Distance	7 m/22.97 feet

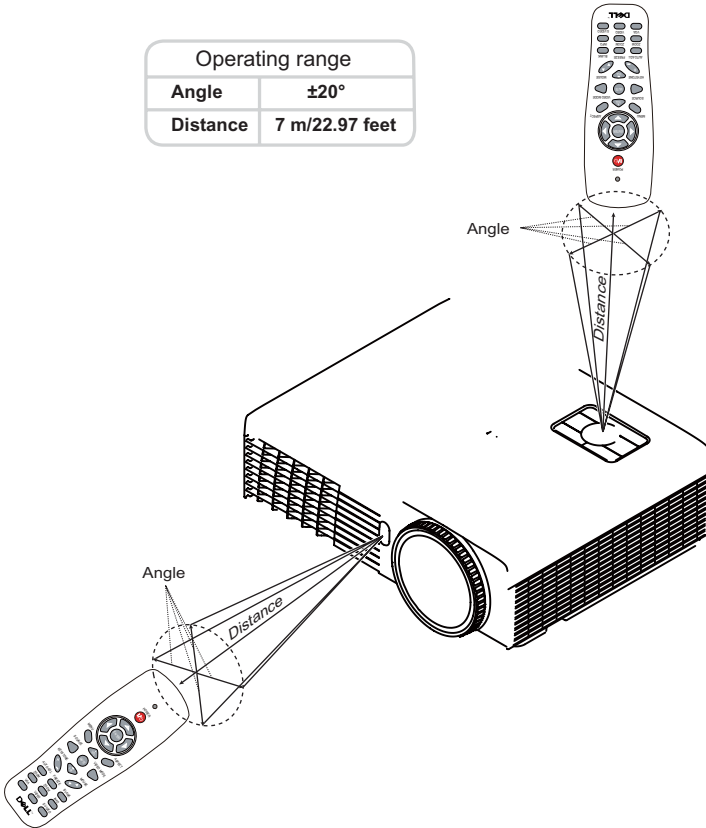

NOTE: Actual operating range may slightly differ from the diagram. Weak batteries will also prevent the remote control from properly operating the projector.



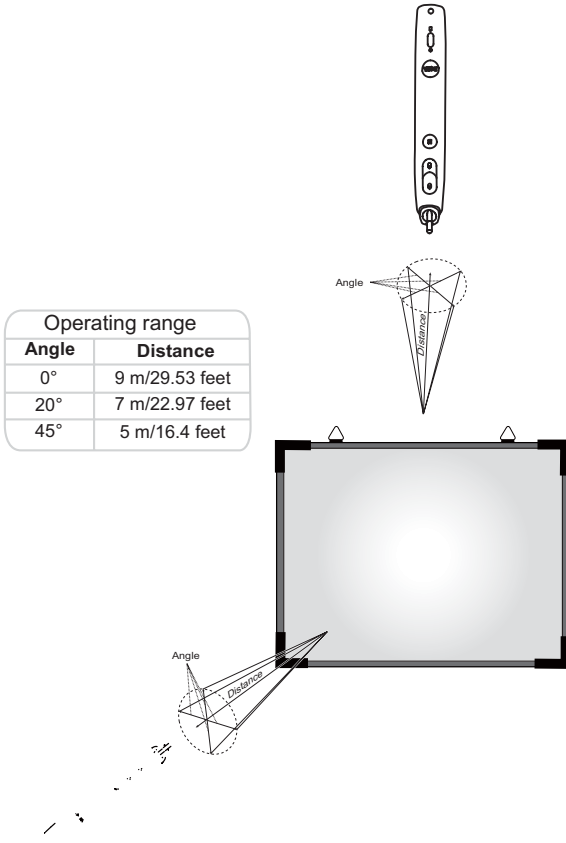





Operating Range with Interactive Pen



NOTE:

- Projector is at 2000 lm brightness, with 100 inches image size, and in Bright mode.
- Can support multiple pens (up to 10 pens) connecting to one projector but the pens cannot be used simultaneously.
- Actual operating range may slightly differ from the diagram.
- The projector brightness decay will affect the operating range of the pen.

Using the On-Screen Display

- The projector has a multi-language On-Screen Display (OSD) Menu that can be displayed with or without an input source.
- Press the Menu button on the control panel or the remote control to enter the Main Menu.
- To navigate through the tabs in the Main Menu, press the  or  buttons on your projector's control panel or remote control.
- To select a submenu, press the  or  button on your projector's control panel or remote control.
- To select an option, press the  or  buttons on your projector's control panel or remote control. When an item is selected, the color changes to dark blue.
- Use the  or  buttons on the control panel or remote control to adjust the settings.
- To go back to the Main Menu, press the  button on the control panel or the remote control.
- To exit the OSD, press the Menu button directly on the control panel or the remote control.

 **NOTE:** OSD structure and set are the same for the S320 and S320wi models.

INPUT SOURCE

The Input Source menu allows you to select your projector's input source.

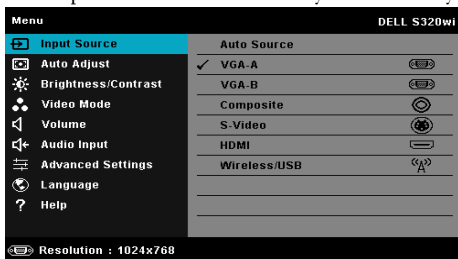

VGA-A—Press  to detect a VGA-A signal.

VGA-B—Press  to detect a VGA-B signal.

COMPOSITE—Press  to detect a Composite Video signal.

S-VIDEO—Press  to detect a S-Video signal.

HDMI—Press  to detect a HDMI signal.

WIRELESS/USB—Press  to activate the Input Source WIRELESS/USB menu.



NOTE: The WIRELESS/USB can be used after the "Wireless and LAN" option is turned on.

INPUT SOURCE WIRELESS/USB

The Input Source Wireless/USB menu allows you to activate the Wireless Display, USB Display, and USB Viewer.

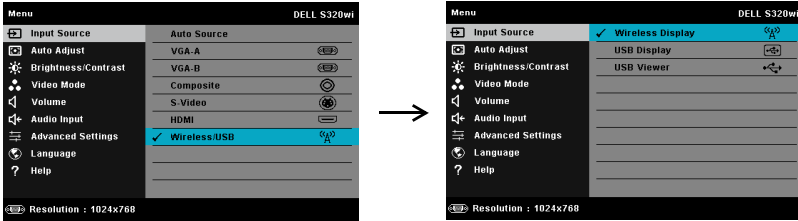

WIRELESS DISPLAY—Press to access the projector's Wireless Guide screen. See "Wireless Guide screen" on page 76.

USB DISPLAY—Allows you to display the computer/laptop screen to your projector via the USB cable.

USB VIEWER—Allows you to display photo and PPT files from your USB flash. See "Presentation to Go (PtG) Installation" on page 83.

AUTO ADJUST

Auto Adjust automatically adjusts the projector's Horizontal, Vertical, Frequency, and Tracking in PC mode.

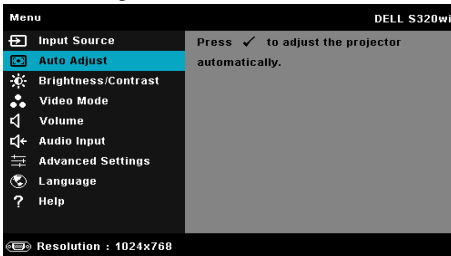

BRIGHTNESS/CONTRAST

The Brightness/Contrast menu allows you adjust the brightness/contrast settings of your projector.

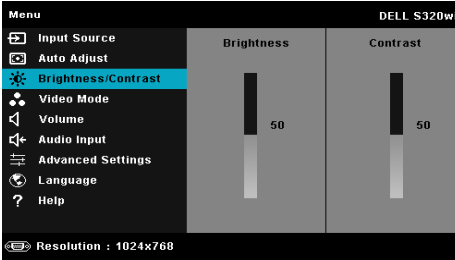

BRIGHTNESS—Use and to adjust the brightness of the image.

CONTRAST—Use and to adjust the display contrast.



NOTE: If you adjust the settings for **Brightness** and **Contrast** the projector automatically switch to Custom mode.

VIDEO MODE

The Video Mode menu allows you to optimize the display image: **Presentation**, **Bright**, **Movie**, **sRGB** (provides more accurate color representation), and **Custom** (set your preferred settings).

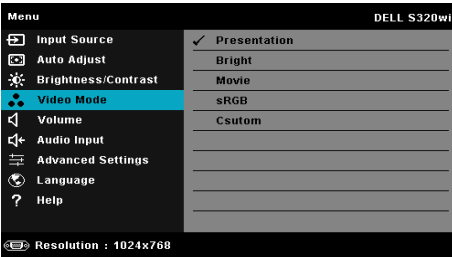

VOLUME

The Volume menu allows you adjust the volume settings of your projector.

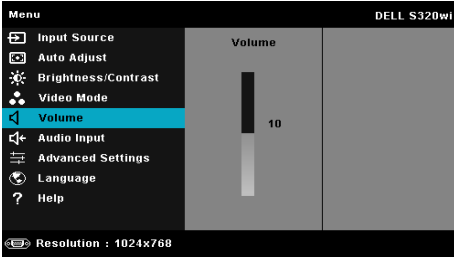

VOLUME—Press to increase the volume and to decrease the volume.

AUDIO INPUT

The Audio Input menu allows you to select your audio input source. The options are: Analog In, HDMI, and Wireless/LAN.

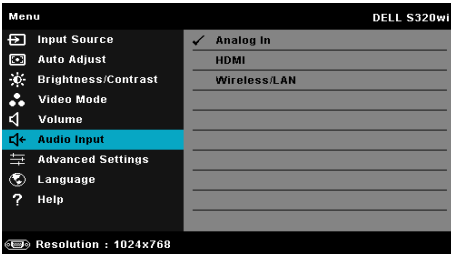

NOTE: Avoid line input signal from plugging into microphone port. Otherwise, user may listen to noises from speakers due to clamping and distortion of audio signal.

ADVANCED SETTINGS

The Advanced Settings menu allows you to change settings for **Image**, **Display**, **Projector**, **LAN**, **Wireless**, **Menu**, **Power**, **Interactive**, and **Information**.

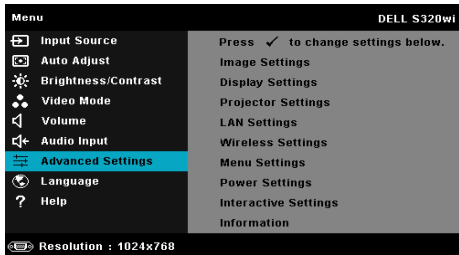
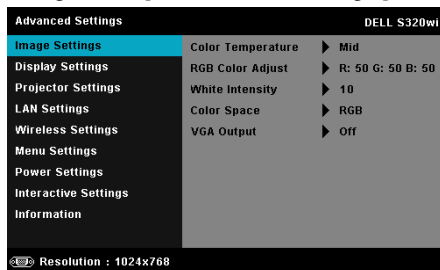

IMAGE SETTINGS (IN PC MODE)—Select and press to activate image settings. The image settings menu provides the following options:



COLOR TEMPERATURE—Allows you to adjust the color temperature. The screen appears cooler at higher color temperatures and warmer at lower color temperatures. When you adjust the values in the **Color Adjust** menu, the Custom mode is activated. The values are saved in the Custom mode.

RGB COLOR ADJUST—Allows you to manually adjust the colors red, green, and blue.

WHITE INTENSITY—Press and use and to display white intensity.

COLOR SPACE—Allows you to select the color space. The options are: RGB, YCbCr, and YPbPr.

VGA OUTPUT—Select On or Off the VGA output function at projector standby status. Default is Off.



NOTE: If you adjust the settings for **Color Temperature**, **RGB Color Adjust**, and **White Intensity** the projector automatically switch to **Custom mode**.

IMAGE SETTINGS (IN VIDEO MODE)—Select and press to activate image settings.

The image settings menu provides the following options:

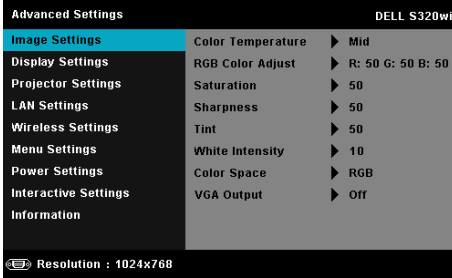

COLOR TEMPERATURE—Allows you to adjust the color temperature. The screen appears cooler at higher color temperatures and warmer at lower color temperatures. When you adjust the values in the **Color Adjust** menu, the Custom mode is activated. The values are saved in the Custom mode.

RGB COLOR ADJUST—Allows you to manually adjust the colors red, green, and blue.

SATURATION—Allows you to adjust the video source from black and white to fully saturated color. Press to increase the amount of color in the image and to decrease the amount of color in the image.

SHARPNESS—Press to increase the sharpness and to decrease the sharpness.

TINT—Press to increase the amount of green in the image and to decrease the amount of green in the image (available for NTSC only).

WHITE INTENSITY—Press and use and to display white intensity.

COLOR SPACE—Allows you to select the color space. The options are: RGB, YCbCr, and YPbPr.

VGA OUTPUT—Select On or Off the VGA output function at projector standby status. Default is Off.



NOTE:

- 1 If you adjust the settings for **Color Temperature**, **RGB Color Adjust**, **Saturation**, **Sharpness**, **Tint**, and **White Intensity** the projector automatically switch to Custom mode.
- 2 **Saturation**, **Sharpness**, and **Tint** only available when the input source is from Composite or S-Video.

IMAGE SETTINGS (NO INPUT SOURCE)—Select and press to activate image settings.

The image settings menu provides the following options:

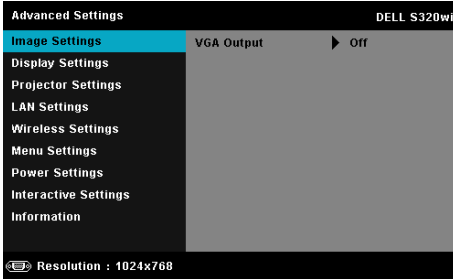

VGA OUTPUT—Select On or Off the VGA output function at projector standby status. Default is Off.

DISPLAY SETTINGS (IN PC MODE)—Select and press to activate display settings. The display settings menu provides the following options:

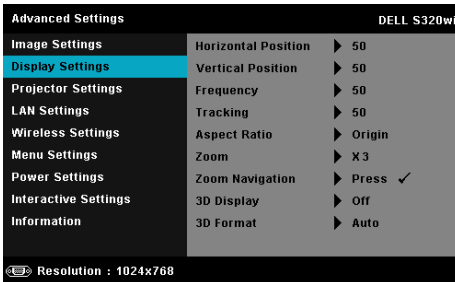

HORIZONTAL POSITION—Press to move the image right and to move the image left.

VERTICAL POSITION—Press to move the image up and to move the image down.



FREQUENCY—Allows you to change the display data clock frequency to match the frequency of your computer's graphics card. If you see a vertical flickering wave, use the Frequency control to minimize the bars. This is a coarse adjustment.

TRACKING—Synchronize the phase of the display signal with the graphic card. If you experience an unstable or flickering image, use Tracking to correct it. This is a fine adjustment.



ASPECT RATIO—Allows you to select the aspect ratio to adjust how the image appears. Options are: Origin, 16:9, and 4:3.

- Origin — Select Origin to maintain the aspect ratio of the image projector according to the input source.

- 16:9 — The input source scales to fit the width of the screen to project a 16:9 screen image.
- 4:3 — The input source scales to fit the screen and projects a 4:3 image.

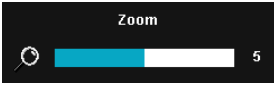



ZOOM—Press  and  to zoom and view the image.

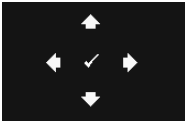

Adjust the image scale by pressing  or  and press  to view on your remote control only.



ZOOM NAVIGATION—Press  to activate the **Zoom Navigation** menu.

Use , , ,  to navigate the projection screen.

3D DISPLAY—Select On to start the 3D display function (default is Off).

 **NOTE:**

1. When you want to create a 3D experience, you will need a few other components including:
 - a Computer/Laptop with a 120 Hz signal output quad-buffered graphics card.
 - b "Active" 3D glasses with DLP Link™.
 - c 3D content. See "Note 4".
 - d 3D Player. (Example: Stereoscopic Player...)
2. Enable the 3D function when it satisfies any of the below-mentioned conditions:
 - a Computer/Laptop with graphics card, capable of outputting at 120 Hz signal via VGA or HDMI cable.
 - b Input a suite of 3D content via Video and S-Video.
3. "3D Display" selection will only be enabled in the "Display Settings of the Advanced Settings" menu when the projector detects either of the inputs mentioned above.
4. 3D support and refresh rate are as below:
 - a VGA/HDMI 1280 x 720, 1024 x 768, and 800 x 600 at 120 Hz
 - b Composite/S-Video at 60 Hz
 - c Component 480i and 576i
5. The recommended VGA signal for laptop is Single-mode output (Dual mode is not recommended).

3D FORMAT—Allows you to select the 3D format. Options are: Side By Side, Side By Side Full, Frame Sequential, Field Sequential, Top/Bottom, and Top/Bottom Full.

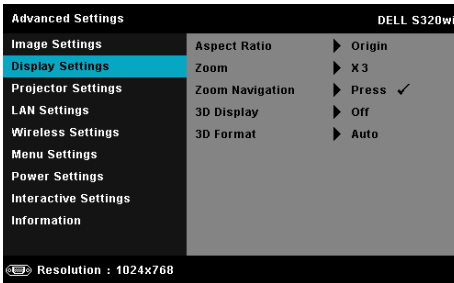

3D SYNC INVERT—If you see a discrete or overlapping image while wearing DLP 3D goggles, you may need to execute 'Invert' to get best match of left/right image sequence to get the correct image. (For DLP 3D goggles)

DISPLAY SETTINGS (IN VIDEO MODE)—Select and press  to activate display settings. The display settings menu provides the following options:





ASPECT RATIO—Allows you to select the aspect ratio to adjust how the image appears. Options are: Origin, 16:9, and 4:3.

- Origin — Select Origin to maintain the aspect ratio of image projector according to the input source.
- 16:9 — The input source scales to fit the width of the screen to project a 16:9 screen image.
- 4:3 — The input source scales to fit the screen and projects a 4:3 image.

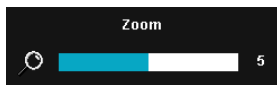



ZOOM—Press  and  to zoom and view the image.



Adjust the image scale by pressing  or  and press  to view on your remote control only.



ZOOM NAVIGATION—Press  to activate the Zoom Navigation menu.

Use     to navigate the projection screen.

3D DISPLAY—Select On to start the 3D display function (default is Off).

 **NOTE:**

1. When you want to create a 3D experience, you will need a few other components including:

- a Computer/Laptop with a 120 Hz signal output quad-buffered graphics card.
 - b "Active" 3D glasses with DLP Link™.
 - c 3D content. See "Note 4".
 - d 3D Player. (Example: Stereoscopic Player...)
2. Enable the 3D function when it satisfies any of the below-mentioned conditions:
 - a Computer/Laptop with graphics card, capable of outputting at 120 Hz signal via VGA or HDMI cable.
 - b Input a suite of 3D content via Video and S-Video.
 3. "3D Display" selection will only be enabled in the "Display Settings of the Advanced Settings" menu when the projector detects either of the inputs mentioned above.
 4. 3D support and refresh rate are as below:
 - a VGA/HDMI 1280 x 720, 1024 x 768, and 800 x 600 at 120 Hz
 - b Composite/S-Video at 60 Hz
 - c Component 480i and 576i
 5. The recommended VGA signal for laptop is Single-mode output (Dual mode is not recommended).

3D FORMAT—Allows you to select the 3D format. Options are: Side By Side, Side By Side Full, Frame Sequential, Field Sequential, Top/Bottom, and Top/Bottom Full.

3D SYNC INVERT—If you see a discrete or overlapping image while wearing DLP 3D goggles, you may need to execute 'Invert' to get best match of left/right image sequence to get the correct image. (For DLP 3D goggles)

PROJECTOR SETTINGS—Select and press  to activate projector settings. The projector settings menu provides the following options:

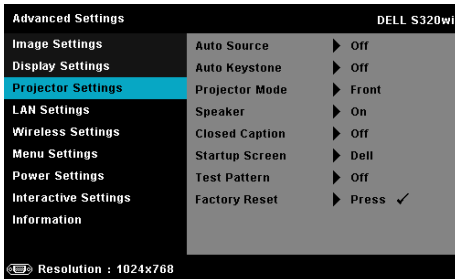

AUTO SOURCE—Select **Off** (the default) to lock the current input signal. If you press the **Source** button when the **Auto Source** mode is set to **Off**, you can manually select the input signal. Select **On** to auto detect the available input signals. If you press the **Source** button when the projector is on, it automatically finds the next available input signal.

AUTO KEYSTONE—Select **On** to automatically adjust image distortion caused by tilting the projector.

PROJECTOR MODE—Allows you to select the projector mode, depending upon how the projector is mounted.

- **Rear Projection-Desktop** — The projector reverses the image so that you can project from behind a translucent screen.
- **Rear Projection-Wall Mount** — The projector reverses and turns the image upside down. You can project from behind a translucent screen with a wall-mounted projection.
- **Front Projection-Desktop** — This is the default option.
- **Front Projection-Wall Mount** — The projector turns the image upside down for wall-mounted projection.

SPEAKER—Select **On** to enable the speaker. Select **Off** to the disable speaker.

CLOSED CAPTION—Select **On** to enable close caption and activate the closed caption menu. Select appropriate closed caption options: CC1, CC2, CC3, and CC4.



NOTE:

1. Closed caption option is available for NTSC only.
2. Closed captioning can only be enabled via S-Video and Composite Video inputs.



STARTUP SCREEN—Default is Dell logo as wallpaper. You can also select **Capture Screen** option to capture the screen display. The following message appears on the screen.



NOTE: To capture a full image, ensure that the input signal connected to the projector is at 1024 x 768 resolution.

TEST PATTERN—Test Pattern is used to test focus and resolution.

You can enable or disable the **Test Pattern** by selecting **Off**, **1**, or **2**. You can also invoke the Test Pattern 1 by pressing and holding down  and .

buttons on the control panel simultaneously for 2 seconds. You can also invoke the test pattern 2 by pressing and holding down  and  buttons on the control panel simultaneously for 2 seconds.

Test Pattern 1:

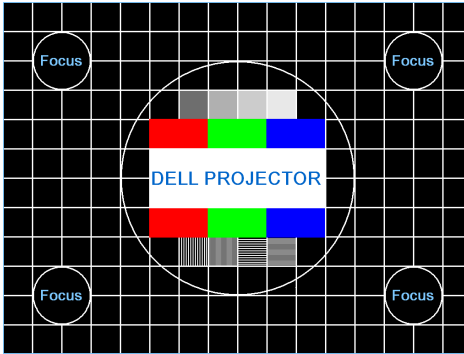

Test Pattern 2:



FACTORY RESET—Select and press  to reset all settings to its factory default. The below warning message appears:

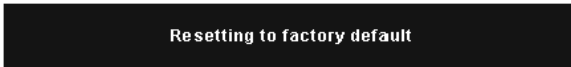



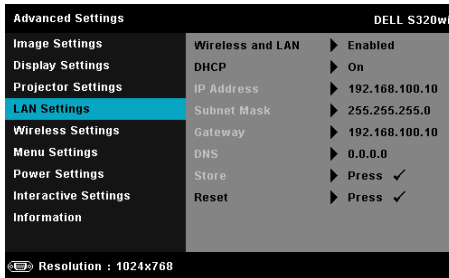

Reset items include both computer sources and Video source settings.

LAN SETTINGS—Select and press  to activate LAN settings. The LAN settings menu provides the following options:



WIRELESS AND LAN—Select Enabled to activate the Wireless and LAN function.

DHCP—If a DHCP server exists in the network to which the projector is connected, the IP address will automatically be acquired when you select DHCP On. If DHCP is Off, manually set the IP Address, Subnet Mask, and Gateway. Use  and  to select the number of IP address, Subnet Mask, and Gateway. Key in enter to confirm each number and then use  and  to set the next item.

IP ADDRESS—Automatically or manually assigns the IP address to the projector connected to the network.









SUBNET MASK—Configure the Subnet Mask of the network connection.

GATEWAY—Check the Gateway address with your network/system administrator if you configure it manually.

DNS—Check the DNS Server IP address with your network/system administrator if you configure it manually.

STORE—Press  to save the changes made in network configuration settings.

 **NOTE:**

1. Use  and  button to select IP Address, Subnet Mask, Gateway, DNS, and Store.
2. Press the  button to enter IP Address, Subnet Mask, Gateway or DNS to set the value. (The selected option is highlighted in blue)
 - a Use  and  button to select the option.
 - b Use  and  button to set the value.
 - c After the setup is complete, press the  button to exit.

3. After the IP Address, Subnet Mask, Gateway, and DNS is set up, select **Store** and press  button to store the settings.
4. If you select **Store** without pressing the **Enter** button, the system will keep the original settings.

RESET—Press  to reset network configuration.

WIRELESS SETTINGS—Select and press  to activate wireless settings. The wireless settings menu provides the following options:

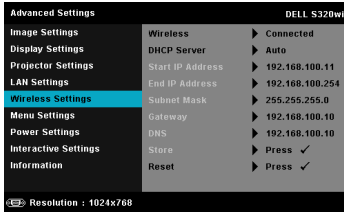

WIRELESS—If your projector has been installed the wireless dongle, this option is the **Connected**.

DHCP SERVER—Allows you to enable DHCP server of the wireless.

START IP ADDRESS—Automatically or manually assigns the Start IP address of the DHCP server to the projector connected to the wireless.

END IP ADDRESS—Automatically or manually assigns the End IP address of the DHCP server to the projector connected to the wireless.









SUBNET MASK—Configure the Subnet Mask of the wireless connection.

GATEWAY—Check the Gateway address with your network/system administrator if you configure it manually.

DNS—Check the DNS Server IP address with your network/system administrator if you configure it manually.

STORE—Press  to save the changes made in wireless configuration settings.

 **NOTE:**

1. Use  and  button to select IP Address, Subnet Mask, Gateway, DNS, and Store.
2. Press the  button to enter IP Address, Subnet Mask, Gateway, or DNS to set the value. (The selected option is highlighted in blue)
 - a Use  and  button to select the option.
 - b Use  and  button to set the value.
 - c After the setup is complete, press the  button to exit.

3. After the IP Address, Subnet Mask, Gateway, and DNS is set up, select **Store** and press  button to store the settings.
4. If you select **Store** without pressing the **Enter** button, the system will keep the original settings.

RESET—Press  to reset wireless configuration.

MENU SETTINGS—Select and press  to activate the menu settings. The menu settings consists of the following options:

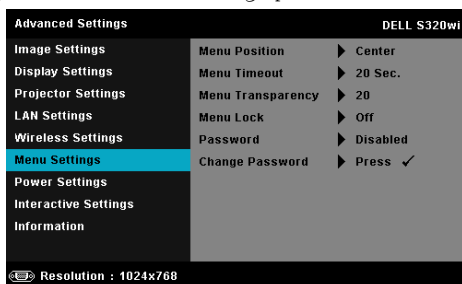

MENU POSITION—Allows you to change the position of the OSD menu on the screen.

MENU TIMEOUT—Allows you to adjust the time for an OSD timeout. By default, the OSD disappears after 20 seconds of non-activity.

MENU TRANSPARENCY—Select to change the transparency level of the OSD background.

MENU LOCK—Select **On** to enable the Menu Lock and hide the OSD menu. Select **Off** to disable the Menu Lock. If you want to disable the Menu Lock function and have the OSD disappear, press the **Menu** button on the control panel or remote control for 15 seconds, and then disable the function.

PASSWORD—When Password Protect is enabled, a Password Protect screen requesting you to enter a password will be displayed when the power plug is inserted into the electrical output and the power for the projector is first turned on. By default, this function is disabled. You can enable this feature by selecting **Enabled**. If the password has been set before, key in the password first and select the function. This password security feature will be activated the next time you turn on the projector. If you enable this feature, you will be asked to enter the projector's password after you turn on the projector:

- 1 First time password input request:

- a Go to **Menu Settings**, press  and then select **Password** to **Enabled** the password settings.

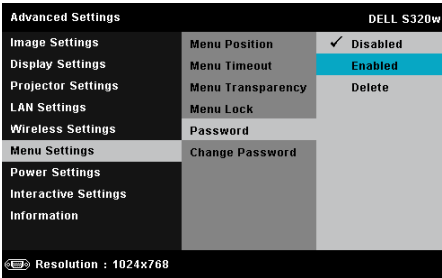

- b Enabling the Password function will pop up a change screen. Key in a 4-digit number from the screen and press .

S320 Password screen

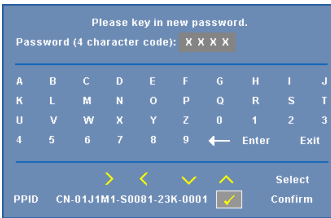

S320wi Password screen

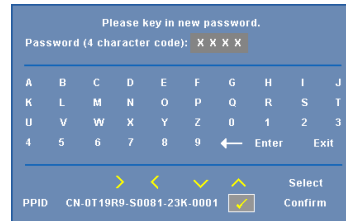

- c To confirm, enter the password again.
- d If the password verification is successful, you may resume with accessing the projector's functions and its utilities.
- 2 If you have entered an incorrect password, you will be given another two chances. After three invalid attempts, the projector will automatically turn off.

 **NOTE:** If you forget your password, contact DELL™ or a qualified service personnel.

- 3 To disable the password function, select the **Disabled** option to close the function.
- 4 To delete the password, select the **Delete** option.

CHANGE PASSWORD—Key in the original password. Then, enter the new password and confirm the new password again.

S320 Change Password screen

S320wi Change Password screen

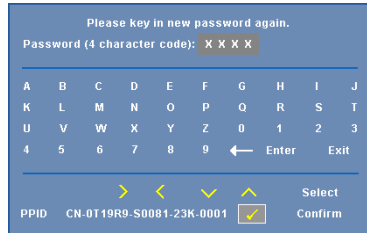
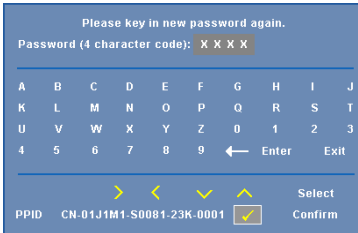
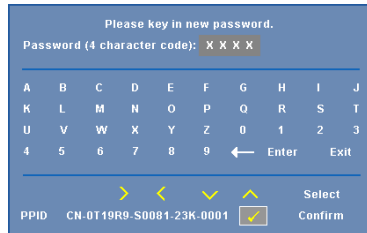
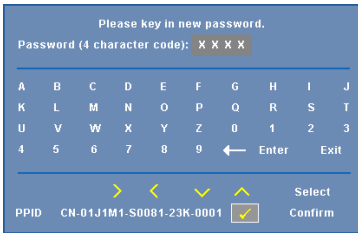
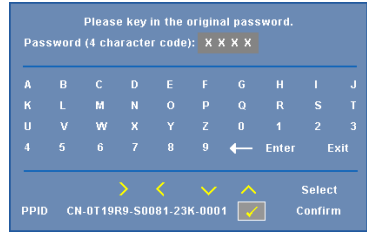
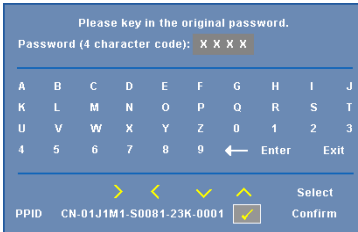

POWER SETTINGS—Select and press  to activate power settings. The power settings menu provides the following options:

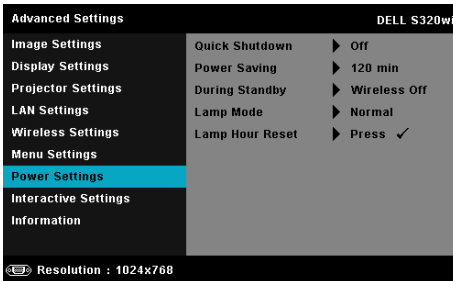

QUICK SHUTDOWN—Select **On** to turn off the projector with a single press of the Power button. This function allows the projector to quickly power off with an accelerated fan speed. Slightly higher acoustic noise is expected during quick power off.



NOTE: Before you turn on the projector again, wait for 60 seconds to allow the internal temperature to stabilize. The projector will take a longer time to turn on if you try to power on immediately. Its cooling fan will run at full speed for about 30 seconds to stabilize the internal temperature.

POWER SAVING—By default, the projector is set to enter power saving mode after 120 minutes of no activity. A warning message appears on screen showing a 60 seconds countdown before switching to power saving mode. Press any button during the countdown period to stop the power-saving mode.

You can also set a different delay period to enter power saving mode. The delay period is the time you want the projector to wait without an input signal.

If an input signal is not detected during the delay period, the projector turns off. To turn on the projector press the Power button.

DURING STANDBY—Select **Wireless On** or **Off** set the Wireless/LAN model on/off while the projector is standby status (default is Wireless Off).

LAMP MODE—Allows you to select the **Normal** or **ECO** or **Dynamic** mode. Normal mode operates at full power level. ECO mode operates at a lower power level which may provide longer lamp life, quieter operation, and dimmer luminance output on the screen.

DYNAMIC—Select and press to activate image care feature.

LAMP HOUR RESET—Press and select the **Confirm** option to reset the lamp hour.

INTERACTIVE SETTINGS—Select and press  to activate Interactive settings. The Interactive settings menu provides the following options:

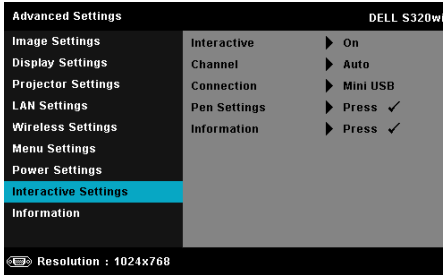

 **NOTE:** The S320 projector must be installed with a Interactive Module Kit if you want to use the Interactive feature. Refer to "Installing the Optional Interactive Module Kit" on page 15.

INTERACTIVE—Default option is On. Select Off to disable the Interactive Pen function.

 **NOTE:**

1. Ensure that the Interactive Pen is connected. See "Connecting With Your Interactive Pen" on page 28.
2. Interactive Pen cannot be used in the extend mode.
3. Interactivity is supported only in the following input modes: VGA and HDMI from a Computer, and Wireless Display, LAN Display, or USB Display.

CHANNEL—Allows you to set the channel selected as Auto or Manual.

- Auto — Channel is selected automatically.
- Manual — Channel is selected manually. A total of 30 channels are available.

CONNECTOR—Allows you to set the connector selection as Mini USB or Wireless/LAN.

PEN SETTINGS—Select and press  to activate Pen settings. The Pen settings menu provides the following options:

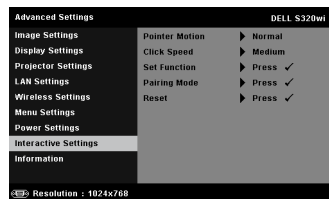
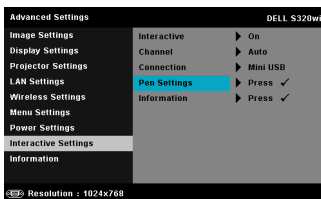

POINTER MOTION—Allows you to select the Pointer Motion mode: Normal, Draw, and Stable.

- Normal — In the Normal mode, pressing the Left button of the Interactive Pen holds the position of the pointer for a moment. This mode is best to use the Interactive Pen like a mouse, i.e., for left click and double click function.
- Draw — In Draw mode, the position can move freely for drawing. This mode is best for drawing or writing on the screen.
- Stable — In the Stable mode, pressing and holding the Left button of the Interactive Pen limits the pointer to vertical or horizontal moves only. If the left button is released, the pointer can resume to move freely. This mode is best for drawing vertical or horizontal lines on the screen.

CLICK SPEED—Allows you to set the mouse pause time. This function is only available in Normal mode. The available options are: Fast, Medium, and Low.

- Fast — Set the pointer motion freeze time to the minimum amount of time, 0.5 seconds.
- Medium — Set the pointer motion freeze time to the middle value, 1.0 seconds.
- Low — Set the pointer motion freeze time to the maximum amount of time, 1.5 seconds

SET FUNCTION—Allows you to set the function of the Function button on the Interactive Pen. Available options are: **Toggle:** Normal/Draw/Stable, PowerPoint Annotation, Switch Windows (Alt + Tab), Esc, Show Desktop (Cmd + D), Open Windows Explorer (Cmd + E), Middle Mouse, Double Click, and Disable (See "Using the Interactive Pen" on page 40).

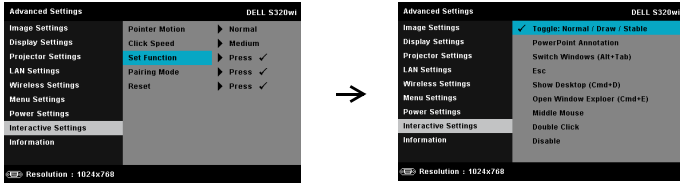

- Toggle: Normal/Draw/Stable — Function as toggling among Normal, Draw, and Stable mode.
- PowerPoint Annotation — Function as annotating in the PowerPoint slide show.

- Switch Windows (Alt + Tab) — Function as toggling among windows, acting as the keyboard shortcut Alt + Tab.
- Esc—Function as the keyboard Esc button.
- Show Desktop (Cmd + D) — Function as showing desktop, minimizing all windows.
- Open Windows Explorer (Cmd + E) — Set the function as opening the Windows Explorer.
- Middle Mouse — Set the function as the scroll wheel of the mouse.
- Double Click — Set the function as double-clicking.
- Disable — Disable the Function button.

PAIRING MODE—Allows you to set the pairing mode selection as Open or Fixed.

- Pairing Mode — When you select **Open**, follow the on-screen steps to set your Interactive Pen into the open mode. (This mode can let you use your Interactive Pen with any Dell interactive projector when the pen points to the screen.)

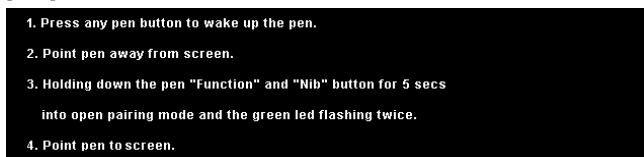

- Fixed Mode — When you select Fixed, follow the on-screen steps to complete the pairing between Projector and Interactive Pen. (This mode is to make sure your Interactive Pen pairing with your designated projector.)

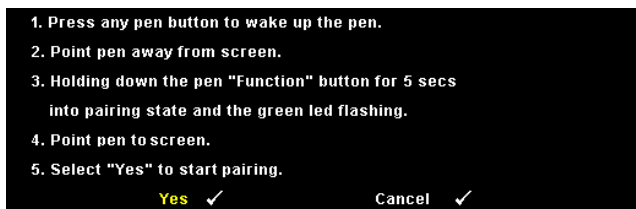

Once paired, the Pen will automatically fix to the projector every time it turns on.

RESET—Press and select Confirm option to reset the Pen settings.

INFORMATION—Allows you to view the Pen 1 or Pen 2 information.

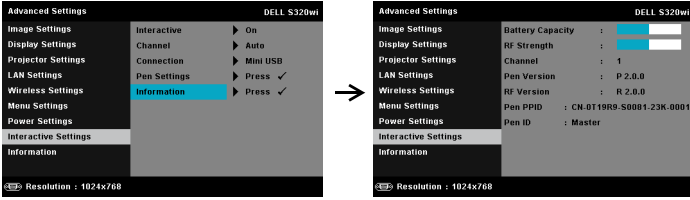

INFORMATION—The information menu displays the current S320 or S320wi projector settings.

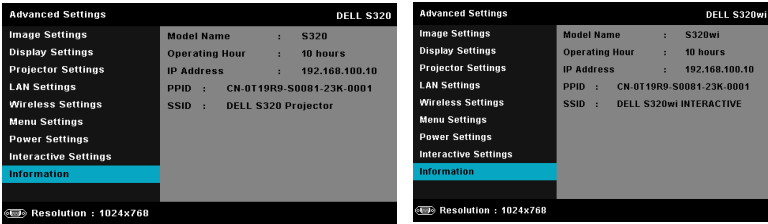

LANGUAGE

Allows you to set the language for the OSD. Press  to activate the Language menu.

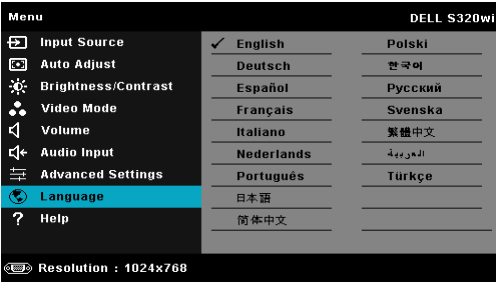

HELP

If you encounter problems with your projector, you can access the help menu for troubleshooting.

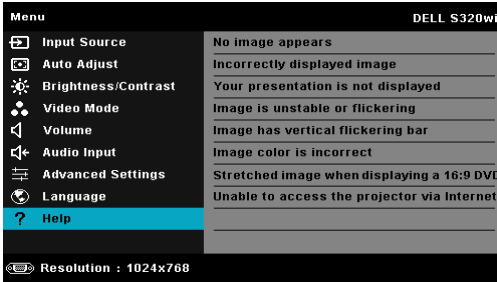

Wireless Networking Installation



NOTE: Your computer must have the following minimum system requirements:

Operating System:

- Windows
Microsoft Windows XP™ Home or Professional Service pack 2 (32-bit recommended), Windows Vista 32-bit, and Windows® 7 Home or Professional 32-bit or 64-bit
- MAC
MacBook and above, MacOS 10.5 and above

Minimum Hardware:

- a** Intel Dual Core 1.4 MHz or higher
- b** 256 MB of RAM required, 512 MB or more recommended
- c** 10 MB of available hard-disk space
- d** nViDIA or ATI graphic card must with 64 MB VRAM or above
- e** Ethernet adapter (10 / 100 bps) for an Ethernet connection
- f** A supported WLAN adapter for a WLAN connection (any NDIS-compliant 802.11b or 802.11g or 802.11n Wi-Fi device)

Web browser

Microsoft Internet Explorer 6.0 or 7.0 (recommended) or 8.0, Firefox 1.5 or 2.0, and Safari 3.0 and above



NOTE: Wireless Networking Installation steps are the same for the S320 and S320wi models.

Enable Wireless on the Projector

In order to use your projector wirelessly, you need to complete the steps below:

- 1 Install the optional wireless module kit (optional in S320). See "Installing the Optional Wireless Module Kit" on page 14.







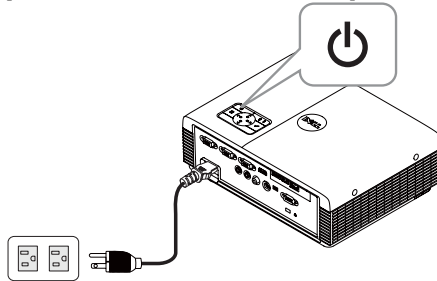

NOTE: Wireless module kit embedded for S320wi.

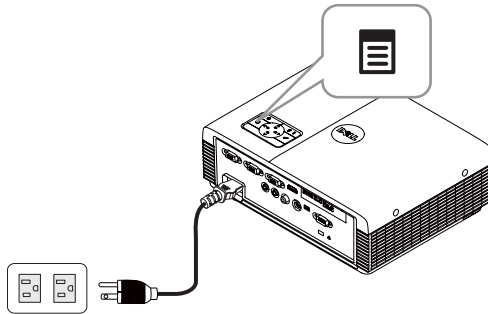
- 2 Connect the power cable to the wall outlet and press the power button.



- 3 Press the Menu button on your projector control panel or remote control.



NOTE: Use , ,  and  buttons to navigate and  to select.

- 4 Access the **INPUT SOURCE** menu, select **Wireless/USB** and then select **Wireless Display** on the sub-menu. See "INPUT SOURCE WIRELESS/USB" on page 52.

The Wireless Guide Screen shown below appears:



- 5 Take note of the **LOGIN CODE**, **NETWORK NAME (SSID)**, and **IP ADDRESS**. You will need these information to log in later.

Install the Wireless Application Software on Your Computer

In order to use your wireless projector, you must install the software on your system.

- 6 Connect your computer to the S320 or S320wi wireless network.

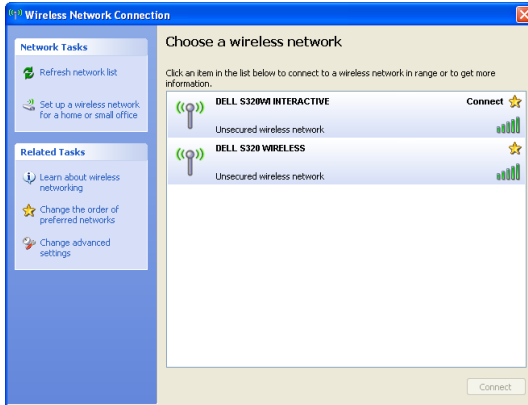

NOTE:

- Your computer must have wireless network function to detect the connection.

- When you connect to the S320 or S320wi wireless network, you will lose wireless connectivity with other wireless networks.

 **NOTE:** Remember to turn off all proxies. (In Microsoft® Windows Vista: Click **Control Panel** → **Internet Options** → **Connections** → **LAN Settings**)

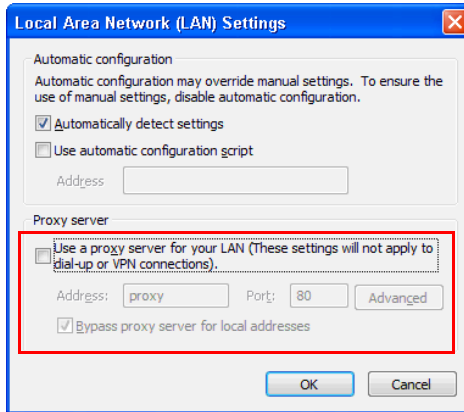

- 7 Open your internet browser. You will be automatically directed to the S320 or S320wi Web Management web page.

 **NOTE:** If the web page does not load automatically, enter the IP address (default IP address is 192.168.100.10) noted from the projector's screen in the browser's address bar.

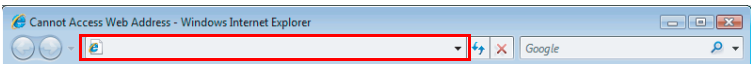

8 The S320 or S320wi Web Management page opens. For first-time use, click Download.

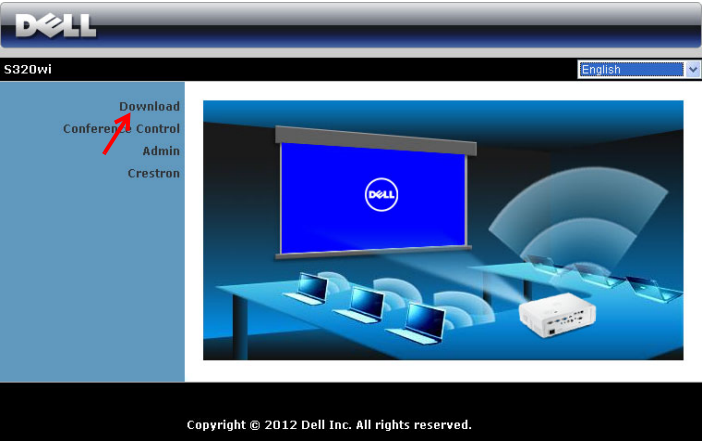

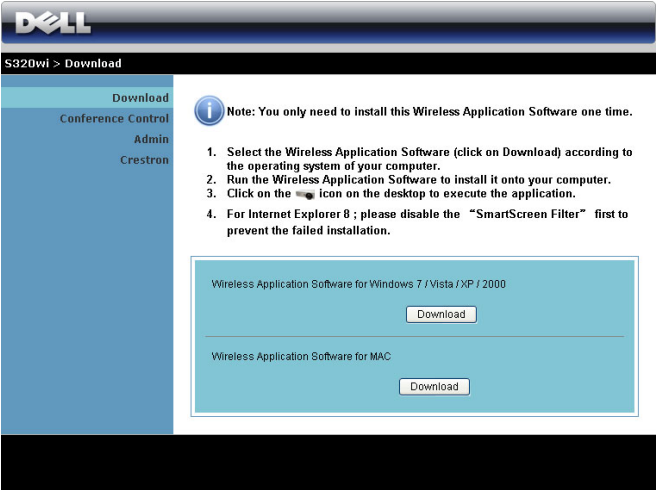

9 Select the appropriate operating system, then click Download.

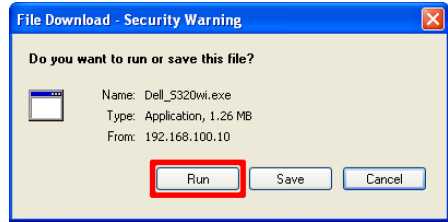

- 10 Click **Run** to proceed with the one-time installation of the software.

 **NOTE:** You may choose to save the file and install it at a latter time. To do this, click **Save**.





 **NOTE:** Audio projection function need install extra driver only in Windows XP. If your computer does not have the driver installed, a pop-up message will appear on-screen prompting you to install the required driver. You can download the "**Audio Projection Driver**" from the Dell Support site at support.dell.com.

 **NOTE:** If you are unable to install the application because of inadequate rights on the computer, please contact your network administrator.

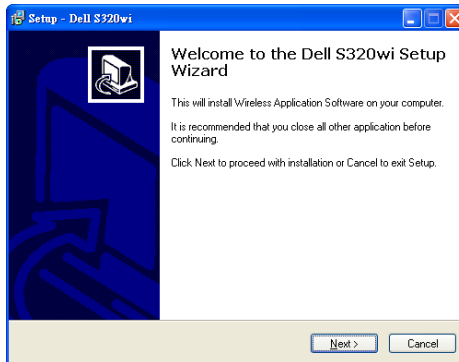
- 11 The installation software will launch. Follow the on-screen instruction to complete setup.



Launch the Wireless Application

Once the installation is complete, the S320 or S320wi wireless application will launch and search automatically. If the program not launch automatically, you can double-click the  or  icon on the desktop to start the application.

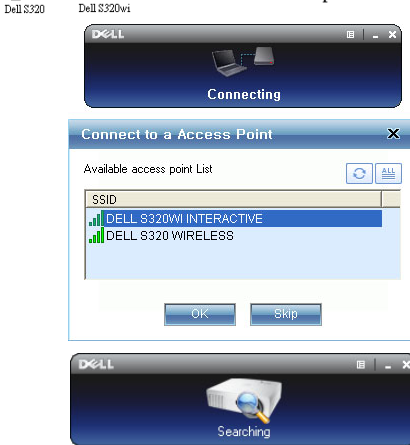

Login

To communicate with your projector, enter the Login Code provided in Step 6 of Wireless Networking Installation, then click **OK**.















 **NOTE:** If the **IP Address** is not detected, enter the **IP Address** displayed at the bottom left corner of the screen.

 **NOTE:** Please not click "**Interactive Pen only**" box in the log in screen when you use the wireless display or LAN display.





Understanding the Buttons

After a successful log in, the following screen appears:





	Item	Description
1	Status Bar	Displays IP and LOGIN CODE information.
	 Menu	Click to activate the application menu.
	 Minimize button	Click to minimize the application.
	 Close button	Click to exit the application.
2	Controls Toolbar	
	 Full screen	Click to project the image in full screen.
	 Split 1	Click to project the image in the upper left corner of the screen.
	 Split 2	Click to project the image in the upper right corner of the screen.
	 Split 3	Click to project the image in the lower left corner of the screen.
	 Split 4	Click to project the image in the lower right corner of the screen.
	 Stop	Click to stop projection.
	 Pause	Click to pause projection.
 Audio Projection	Click to enable audio projection.	
3	Connection Status	
	 Connection Icon	Blinks when projection is in progress.

Projecting the Presentation

- To project the presentation, click any of the projection buttons .
- To pause the presentation, click . The icon turns green.
- To continue the presentation, click  again.
- To audio projection the presentation, click .

- To stop the presentation, click .

 **NOTE:** WLAN environment using 802.11g connection, and no screen stretching.

 **NOTE:** Your computer will not enter S1 (standby mode) / S3 (sleep mode) / S4 (hibernate mode) when running a wireless, USB Display, or USB Viewer presentation.

Using the Menu

Click  to display the menu.



WEB MANAGEMENT—Click to open the Web Management page. See "Managing the Projector From Web Management (for Wireless Network)" on page 95.

SEARCH FOR PROJECTOR—Click to search and connect to wireless projector.

MAKE APPLICATION TOKEN—Click to make application token. See "Make Application Token" on page 125.

ADVANCE SCREEN CAPTURE—The default is enable. Click to disable the advance screen capture.

INFO—Click to display system information.

HOTKEY—Click to display the hotkey information.

ABOUT—Click to display the application version.

EXIT—Click to close the application.

Presentation to Go (PtG) Installation

Minimum system requirements to install PtG are as follow:

Operating System:

- Windows

Microsoft Windows XP™ Home or Professional Service pack 2/3 (32-bit recommended), Windows® Vista 32-bit, or Windows® 7 Home or Professional 32-bit or 64-bit

- Office 2003 or Office 2007



NOTE: Presentation to Go (PtG) installation steps are the same for the S320 and S320wi models.

In order to use your USB Viewer, you need to complete the steps below:

- 1 Install the optional wireless module kit. See "Installing the Optional Wireless Module Kit" on page 14.



NOTE: Wireless module kit embedded for S320wi (optional in S320).

- 2 Plug the USB Flash to your projector.



NOTE:

- Only supports the JPEG format photo within 10 Mb x 40 M pixels.
- The PtG converter can convert your PowerPoint files into PtG files. See "Using the PtG Converter" on page 87.
- You can download the "PtG Converter - Lite" in the Dell Support website at: support.dell.com.

- 3 At **INPUT SOURCE** menu, select **Wireless/USB** and then select **USB Viewer** on the sub-menu. See "INPUT SOURCE WIRELESS/USB" on page 52.



NOTE: When the Wireless and LAN function is disabled, go to **LAN Settings** menu, select the **"Enabled"** in the **"Wireless and LAN"** option to re-activate the Wireless and LAN function.

PtG Viewer

System will stay in this page when ready.



Photo Viewer

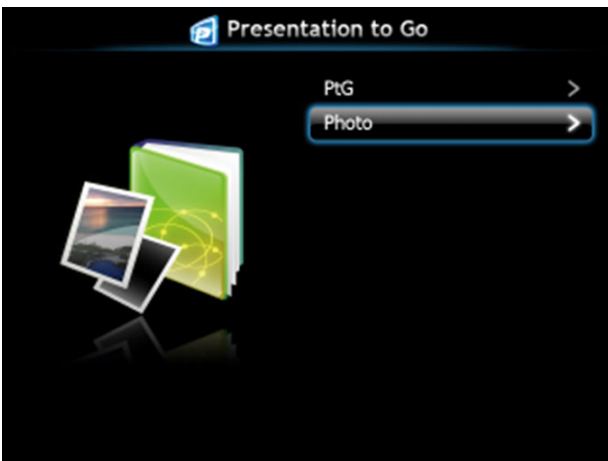

PtG/Photo Function Introduction

Show valid PtG and Photo files which are stored in the USB disk.

 **NOTE:** If only one disk is detected, the system will skip this step.

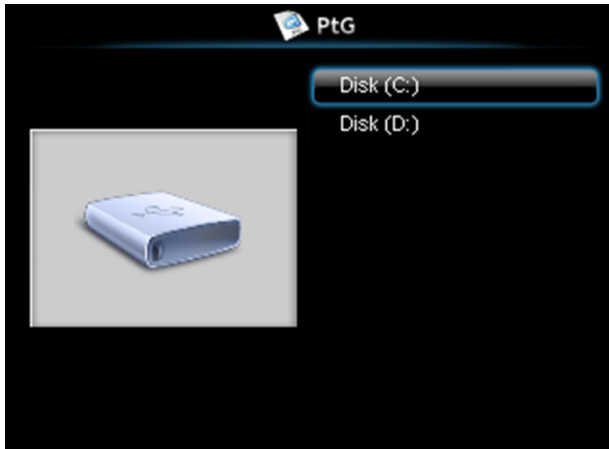

PtG Overview





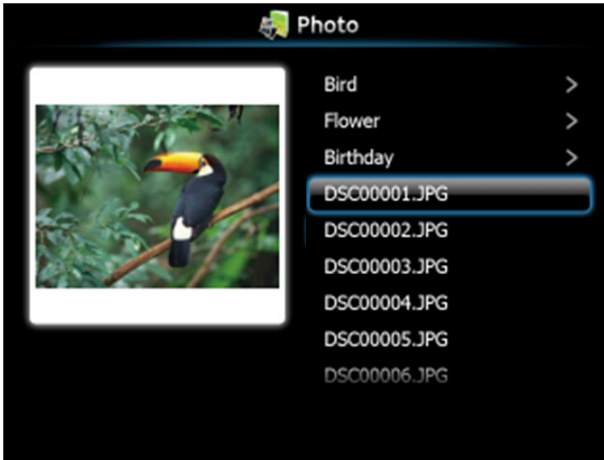

Photo Overview



NOTE: Supports 14 languages of photo files name format (Languages: English, Dutch, French, German, Italian, Japanese, Korean, Polish, Portuguese, Russian, Simplified Chinese, Spanish, Swedish, and Traditional Chinese).

Buttons Introduction

Use the **up**, **down**, and **left** buttons to navigate and **Enter** button on your projector's control panel or remote control to select.

Button	Up 	Down 	Left 	Right 	Enter 
PtG function	Up	Down	Back	No function	Enter
PtG Playback	Pre Page	Next Page	Back	No function	Next Pause
Photo function	Up	Down	Back	No function	Enter
Photo Playback	Pre Page	Next Page	Back	No function	No function

NOTE: If you enter the OSD menu while using PtG, PtG navigation by the up, down, and left buttons will not function.

Install the PtG Converter Application Software on Your Computer

Please follow the on-screen instructions to complete the setup.

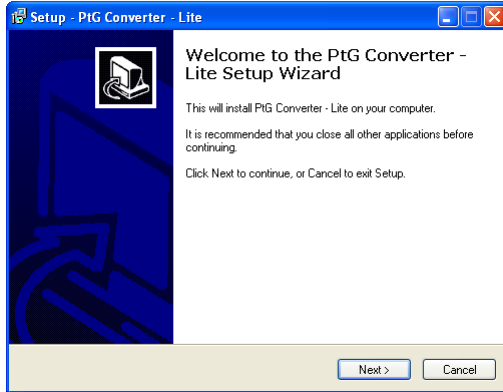

NOTE: You can download the "PtG Converter - Lite" in the Dell Support website at support.dell.com.

Using the PtG Converter

- 1 Launch the "PtG Converter - Lite.exe" or double-click the  icon on the desktop to start the application.



- 2 Click  to select a PowerPoint file and start conversion.

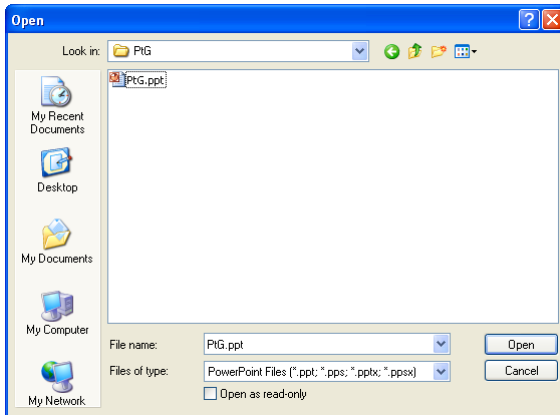

- 3 Click **Browse** button to select the storage location and then press OK.

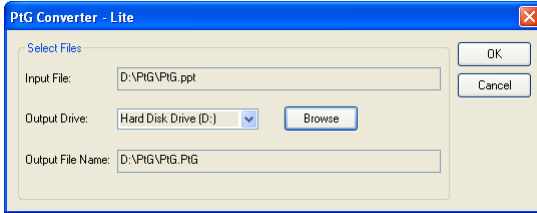

NOTE:

- 1 If your computer does not have MS PowerPoint installed, file convert will fail.
- 2 PtG converter only supports up to 20 pages.
- 3 PtG converter only supports conversion of .ppt files to .PtG files.

Audio Projection Installation

Audio Projection only supports the **Wireless Display** and **LAN Display** input source.

Minimum system requirements as follow:

Operating System:

- Windows
Microsoft Windows XP™ Home or Professional Service pack 2/3 (32-bit recommended), Windows Vista 32-bit, or Windows® 7 Home or Professional 32-bit or 64-bit
- MAC
MacBook Pro and above, MacOS 10.5 and above

Minimum Hardware:

- a** Intel® Core™ i5-460 MHz (2.53 GHz/Turbo 2.8 GHz) or greater
- b** 1 GB DDR3 VRAM independent graphics card or more recommended
- c** 2 GB dual channel DDR3 SDRAM memory at 1066 MHz required or more recommended
- d** Gigabit Ethernet
- e** Integrated 802.11 b/g/n Wi-Fi Device for a WLAN connection



NOTE: If your computer does not meet the minimum hardware requirements, audio projection may have lag or noise. Meet the recommended system requirements to have optimized performance of audio projection.



NOTE: If you want to use wireless for audio projection, need installed the optional wireless dongle. See "Installing the Optional Wireless Module Kit" on page 14.



NOTE: Audio projection function need install extra driver only in Windows XP, If your computer does not have the driver installed, a pop-up message will appear on-screen prompting you to install the required driver. You can download the "**Audio Projection Driver**" from the Dell Support site at support.dell.com.



NOTE: Audio Projection function need installed extra drive in MAC operating system. If your MAC computer does not have the driver installed, a pop-up message will appear on-screen prompting you to install the required driver. You can download the "**Soundflower Driver**" from the some search engine sites (ex. Yahoo, MSN...). The "**Soundflower Driver**" is free application.



NOTE: Audio projection setting steps are the same for the S320 and S320wi models.



NOTE: Ports / Protocol for connection to the projector for projection via Ethernet:

UDP:	1047,	(backup: 1048, 1049)
TCP:	3268, 515, 1688, 1041	(backup: 389, 8080, 21)

Enable Wireless or LAN on the Projector

- 1 Install the optional wireless module kit (optional in S320). See "Installing the Optional Wireless Module Kit" on page 14.



NOTE: If you select install the LAN module kit (optional), see "Installing the Optional RJ45 Kit" on page 16.

- 2 Connect the power cable and turn on the projector by pressing the power button.

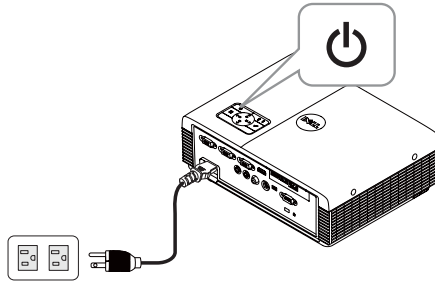

NOTE:

- a If the **LAN** is used for audio projection, follow these steps to enable Wireless and LAN function (default is **Enabled**): Advanced Settings → LAN Settings → Wireless and LAN → Enabled.
 - b If the **Wireless** is used for audio projector, please install a wireless dongle to your projector.
- 3 Access the **Input Source** menu, select the **Wireless/USB** and then select the **Wireless Display** on the sub-menu.

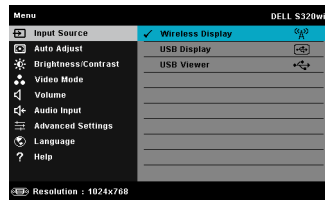
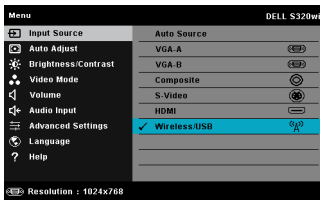

The Wireless Guide Screen shown below appears:



- 4 Take note of the **LOGIN CODE**, **NETWORK NAME (SSID)**, and **IP ADDRESS**. You will need these information to log in later.

Install the Wireless Application Software on Your Computer

- 5 "Wireless Application Software" is required if the Wireless or LAN is used for the Audio Projection set-up. Please download and install the software the first time you use Audio Projection. If it is already installed, skip Step 5 - 6.



NOTE: You only need to install the "Wireless Application Software" once.

- 6 Wireless Application Software download and install steps refer to steps 7 to 12 of the "Wireless Networking Installation" on page 74.

 **NOTE:** If the LAN is used for audio projection, connect the LAN cable to the projector and the computer.

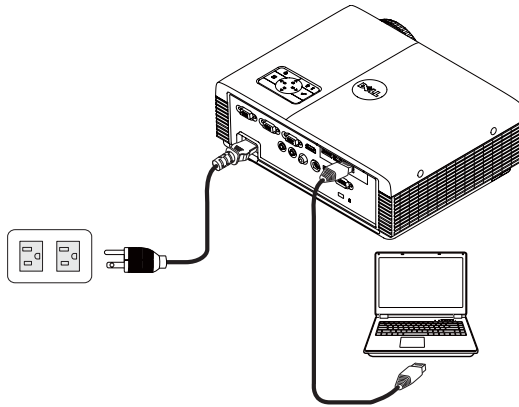

Launch the Wireless Application

- 7 Once the installation is complete, the program will launch automatically. Or you can double-click the  or  icon on the desktop to start the application.

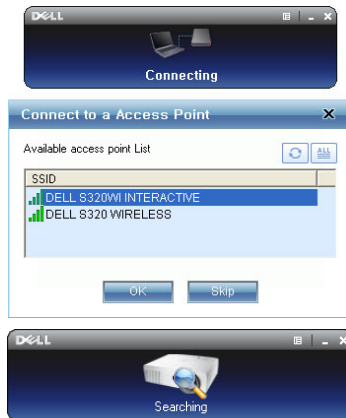

 **NOTE:**

- 1 When you select the LAN for projection, click "Skip".
- 2 When you select the Wireless for projection, select the **Dell S320 Wireless** or **Dell S320wi Interactive**, and the click "OK".

Login

- To communicate with your projector, enter the Login Code (see Step 4), and then click OK.

 **NOTE:** If the **IP Address** is not detected, enter the **IP Address** displayed at the bottom left corner of the wireless screen.

- You are now logged into the S320 or S320wi Wireless Application. Click the "Play" button in the application to starting the LAN or wireless projection.



 **NOTE:** You may use the controls to either project in full screen mode or in split screen mode.

- Click the "Audio Projection" button in the application to enable Audio Projection function.



 **NOTE:** Audio Projector function need install extra driver only in Windows XP, if your computer does not have the driver installed, a pop-up message will appear on-screen prompting you to install the required driver. You can download the "Audio Projection Driver" from the Dell Support site at support.dell.com.

- Executing the Windows Media Player or others audio player software (example: Winamp player...) on your computer.



Managing the Projector From Web Management (for Wireless Network)

Configuring the Network Setting

If the projector is connected to a network, you can access the projector using a web browser. For configuring the network setting, refer to "LAN Settings" on page 63.

Accessing Web Management

Use Internet Explorer 5.0 and above or Firefox 1.5 and above and enter the IP address. You can now access Web Management and manage the projector from a remote location.



NOTE: Web management and set are the same for the S320 and S320wi models.

Home Page



- Access the Web Management Home page by entering the projector's IP address at the web browser. See "LAN Settings" on page 63.
- Select the language for web management from the list.
- Click any menu item on the left tab to access the page.

Download the Wireless Application Software

See also "Wireless Networking Installation" on page 74.

DELL

S920wi > Download

Download
Conference Control
Admin
Crestron

i Note: You only need to install this Wireless Application Software one time.

1. Select the Wireless Application Software (click on Download) according to the operating system of your computer.
2. Run the Wireless Application Software to install it onto your computer.
3. Click on the icon on the desktop to execute the application.
4. For Internet Explorer 8; please disable the "SmartScreen Filter" first to prevent the failed installation.

Wireless Application Software for Windows 7 / Vista / XP / 2000
[Download](#)

Wireless Application Software for MAC
[Download](#)

Click the **Download** button of the corresponding operating system of your computer.

Conference Control

This allows you to host conference presentations from different sources without using projector cables and lets you control how each presentation will appear on screen.



NOTE: Without Conference Play Control, the last user to hit the "Play" button on the application will take control of the full-screen projection.

Computer Name: Lists the computers logged for conference control.

Play Control: Click the buttons to control how each computer's projection will appear on screen.

- Full screen projection — The presentation from the computer occupies the whole screen.
- Split 1 - The presentation from the computer appears on the upper left corner of the screen.
- Split 2- The presentation from the computer appears on the upper right corner of the screen.
- Split 3- The presentation from the computer appears on the lower left corner of the screen.
- Split 4- The presentation from the computer appears on the lower right corner of the screen.
- Stop - Projection from the computer is stopped.

IP Address: Shows each computer's IP Address.

NOTE: To end the conference, click **Home**.

Managing Properties

Admin

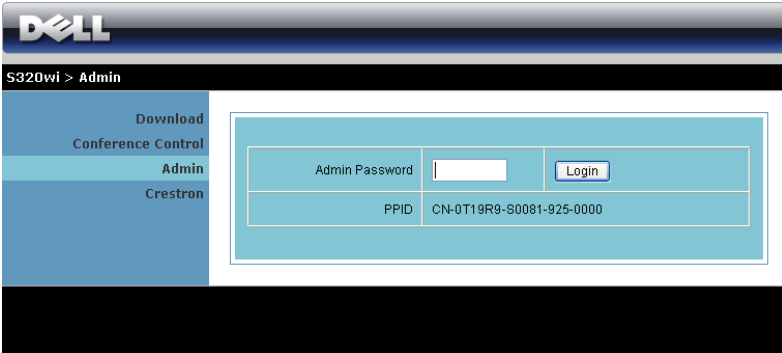

An administrator password is required to access the Admin page.

- **Admin Password:** Enter the administrator password and then click **Login**. The default password is "admin". To change the password, see "Change Passwords" on page 103.

System Status

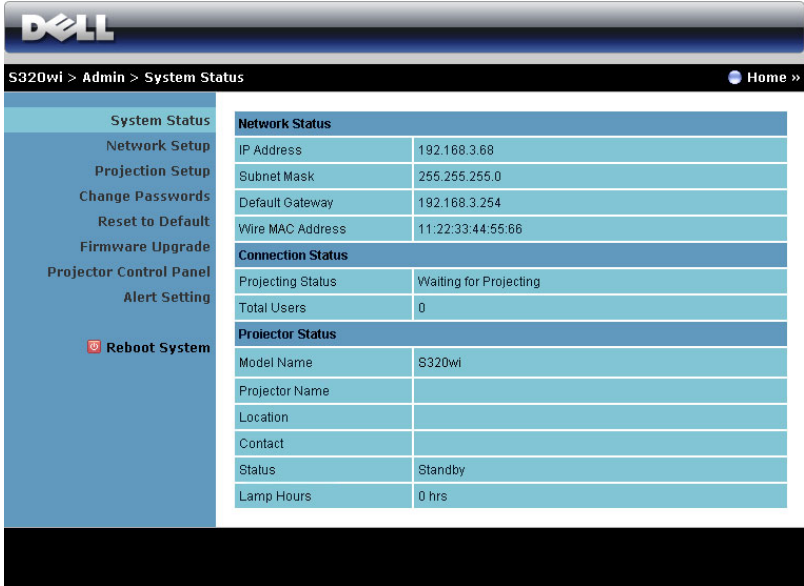

DELL

S320wi > Admin > System Status Home »

System Status	Network Status	
Network Setup	IP Address	192.168.3.68
Projection Setup	Subnet Mask	255.255.255.0
Change Passwords	Default Gateway	192.168.3.254
Reset to Default	Wire MAC Address	11:22:33:44:55:66
Firmware Upgrade	Connection Status	
Projector Control Panel	Projecting Status	Waiting for Projecting
Alert Setting	Total Users	0
 Reboot System	Projector Status	
	Model Name	S320wi
	Projector Name	
	Location	
	Contact	
	Status	Standby
	Lamp Hours	0 hrs

Displays the Network Status, Connection Status, and Projector Status information.

Network Status

See OSD section on page 63.

The screenshot shows the Dell S320Wi Network Setup interface. The left sidebar contains navigation options: System Status, Network Setup (selected), Projection Setup, Change Passwords, Reset to Default, Firmware Upgrade, Projector Control Panel, Alert Setting, and Reboot System. The main content area is divided into several sections:

- IP Setup:** Radio buttons for "Obtain an IP address automatically" (selected) and "Use the following IP address". Fields for IP Address (192, 168, 100, 10), Subnet Mask (255, 255, 255, 0), Default Gateway (192, 168, 100, 10), and DNS Server (192, 168, 100, 10).
- DHCP Server Setup:** Radio buttons for "Auto" (selected) and "Disable". Fields for Start IP (192, 168, 100, 11), End IP (192, 168, 100, 254), Subnet Mask (255, 255, 255, 0), Default Gateway (192, 168, 100, 10), and DNS Server (192, 168, 100, 10).
- Wireless Setup:** Radio buttons for "Wireless LAN" (Enable selected, Disable unselected). Fields for Region (--- WORLDWIDE ---), SSID (DELL S320WI INTERACTIVE), SSID Broadcast (Enable selected, Disable unselected), Channel (Auto), Encryption (Disable), and Key.
- RADIUS Server Setup:** Fields for IP Address (192, 168, 100, 10), Port (1812), and Key.
- GateKeeper:** Radio buttons for "All Pass" (unselected), "All Block" (selected), and "Internet Only" (unselected).
- Set Security For SNMP:** Field for Write Community (private).

Buttons for "Apply" and "Cancel" are located at the bottom right of the configuration area.

IP Setup

- Choose **Obtain an IP address automatically** to assign an IP address to the projector automatically, or **Use the following IP address** to assign an IP address manually.

DHCP Server Setup

- Choose **Auto** to automatically set up the **Start IP**, **End IP**, **Subnet Mask**, **Default Gateway**, and **DNS Server** address from a DHCP server, or **Disable** to disable this function.

Wireless Setup

- Choose **Enable** to set up the **Region**, **SSID**, **SSID Broadcast**, **Channel**, **Encryption**, and **Key**. Choose **Disable** to disable the wireless set up.

SSID: Up to maximum length of 32 characters.

Encryption: You can **Disable** WPA key or select one of 64-bit or 128-bit in ASCII or HEX string.

Key: If Encryption is enabled, you have to set key value according to the Encryption mode you selected.

RADIUS Server Setup

- Set up the IP address, Port, and Key information.

GateKeeper

- There are three options:

All Pass: Allow users to access the office network via the wireless projector.

All Block: Block users from accessing the office network via the wireless projector.

Internet Only: Block users from the office network, but still reserve Internet connection capability.

Set Security For SNMP

- Setup Write Community information.

Click the **Apply** button to save and apply changes. The projector must be restarted for the changes to take effect.

Projection Setup

The screenshot shows the Dell S320wi Admin interface. The breadcrumb navigation is "S320wi > Admin > Projection Setup". The left navigation menu includes: System Status, Network Setup, **Projection Setup**, Change Passwords, Reset to Default, Firmware Upgrade, Projector Control Panel, Alert Setting, and Reboot System. The main content area is divided into two sections: "Projection Setup" and "Projector Setup".

Projection Setup	Resolution	WXGA (1280x800) ▾
	Login Code	<input type="radio"/> Disable <input checked="" type="radio"/> Random <input type="radio"/> Use the following code <input type="text"/>
	Projector Setup	Model Name: S320wi Projector Name: D06486 Location: <input type="text"/> Contact: <input type="text"/>

Buttons: Apply, Cancel

Projection Setup

- **Resolution:** Allows you to select the resolution. Options are: XGA (1024 x 768) and WXGA (1280 x 800).
- **Login Code:** Select how you want the login code to be generated by the projector. There are three options:
 - **Disable:** Login code will not be required when logging in to the system.
 - **Random:** Default is **Random**. Login code will be randomly generated.
 - **Use the following code:** Enter a 4-digit code. This code will be used to log in to the system.

Projector Setup

- Set up the **Model Name**, **Projector Name**, **Location**, and **Contact** information (up to 21 characters for each field).

Click the **Apply** button to save and apply changes. The projector must be restarted for the changes to take effect.

Change Passwords

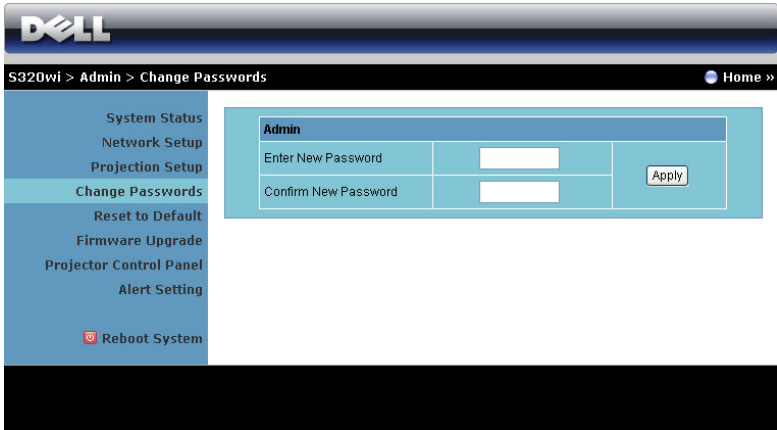

The screenshot shows the Dell S320wi Admin interface. The top navigation bar includes the Dell logo, the breadcrumb "S320wi > Admin > Change Passwords", and a "Home" link. A left-hand menu lists various system settings, with "Change Passwords" highlighted. The main content area is titled "Admin" and contains two input fields: "Enter New Password" and "Confirm New Password", each with a corresponding text box. An "Apply" button is located to the right of the second input field.

This page allows you to change the administrator password.

- **Enter New Password:** Enter the new password.
- **Confirm New Password:** Enter the password again and click **Apply**.



NOTE: Contact Dell if you forget your administrator password.

Reset to Default

The screenshot shows the Dell S320wi Admin interface. At the top, there is a navigation bar with the Dell logo and the breadcrumb path: S320wi > Admin > Reset to Default. A 'Home' button is visible in the top right corner. On the left side, there is a vertical menu with the following options: System Status, Network Setup, Projection Setup, Change Passwords, Reset to Default (highlighted), Firmware Upgrade, Projector Control Panel, Alert Setting, and Reboot System. The main content area is light blue and features a warning icon (a yellow triangle with an exclamation mark) next to the heading 'Reset to Default'. Below the heading, the text reads: 'This will restore the Wireless/Network to factory default settings.' At the bottom of this section, there is a white 'Apply' button.

Click the **Apply** button to restore the wireless/network setup to its factory default settings.

Firmware Upgrade

Use the Firmware Upgrade page to update your projector's wireless firmware.

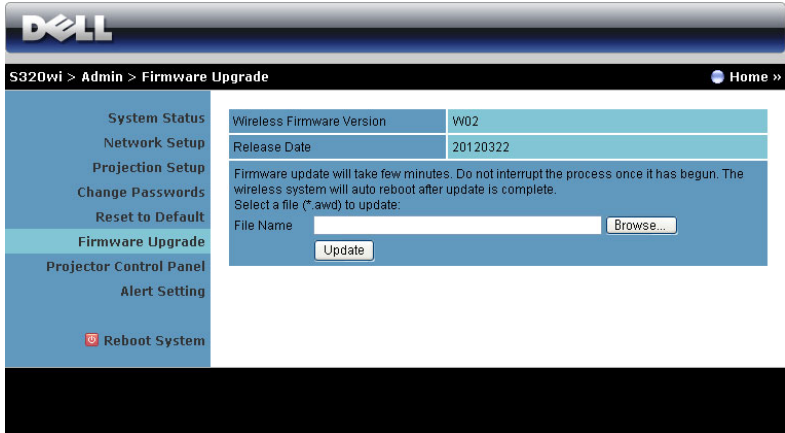

 **NOTE:** Please disable and enable wireless/network using the OSD to restart the network card for the projector after firmware upgrade is successful.

To start firmware update, follow these steps:

- 1 Press **Browse** to select the file to update.
- 2 Click the **Update** button to start. Wait while the system updates the firmware in your device.

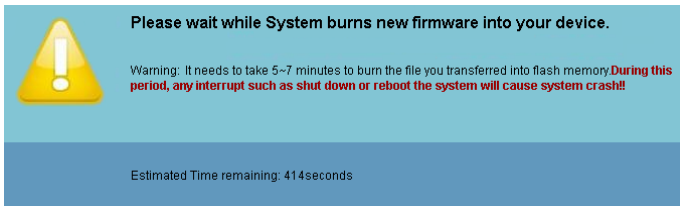

 **CAUTION:** Do not interrupt the update process as this may cause the system to crash!

- 3 Click **OK** when the update is complete.

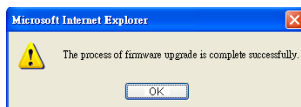

Projector Control Panel

DELL

S320wi > Admin > Projector Control Panel Home »

- System Status
- Network Setup
- Projection Setup
- Change Passwords
- Reset to Default
- Firmware Upgrade
- Projector Control Panel**
- Alert Setting
- Reboot System

Projector Information

Projector Status	On	Refresh
Power Saving	120 min. ▾	Power ON Power OFF
Alert Status	Good	Clear

Image Control

Projector Mode	Front Projection-Desktop ▾
Source Select	None ▾
Video Mode	Presentation Mode ▾
Blank Screen	<input type="radio"/> On <input checked="" type="radio"/> Off
Aspect Ratio	<input checked="" type="radio"/> Original <input type="radio"/> 4:3 <input type="radio"/> Wide
Brightness	50 (0-100) Set
Contrast	50 (0-100) Set
Auto Adjust	

Audio Control

Audio Input	Audio-A ▾
Volume	10 (0-20) Set
Speaker	<input checked="" type="radio"/> On <input type="radio"/> Off
Factory Reset	

Projector Information

- **Projector Status:** There are five states: Lamp On, Standby, Power Saving, Cooling, and Warming up. Click **Refresh** to refresh the status and control settings.
- **Power Saving:** Power Saving can be set to Off, 30, 60, 90, or 120 minutes. For more information, see "Power Saving" on page 68.
- **Alert Status:** There are three alert states: Lamp warning, Low lamp life, and Temperature warning. Your projector might lock up in the protection mode if any of the alerts are activated. To exit the protection mode, click **Clear** to clear the Alert Status before you power on your projector.

Image Control

- **Projector Mode:** Allows you to select the projector mode, depending on how the projector is mounted. There are four projection modes: Front Projection-Desktop, Front Projection-Wall Mount, Rear Projection-Desktop, and Rear Projection-Wall Mount.
- **Source Select:** The Source Select menu allows you to select your projector's input source. You can select VGA-A, VGA-B, S-Video, Composite Video, HDMI, Wireless Display, USB Display, or USB Viewer.
- **Video Mode:** Select a mode to optimize the display image based on how the projector is being used:
 - **Presentation:** Best for presentation slides.
 - **Bright:** Maximum brightness and contrast.
 - **Movie:** For viewing movies and photos.
 - **sRGB:** Provides a more accurate color representation.
 - **Custom:** User-preferred settings.
- **Blank Screen:** You can select On or Off.
- **Aspect Ratio:** Allows you to select the aspect ratio to adjust how the image appears.
- **Brightness:** Select value to adjust the brightness of the image.
- **Contrast:** Select value to adjust the display contrast.

Click the **Auto Adjust** button to adjust the settings automatically.

Audio Control

- **Audio Input:** Select the input source. Options are: Analog In, HDMI, and Wireless/LAN.
- **Volume:** Select the value (0~20) for audio volume.
- **Speaker:** Select **On** to enable the audio function or select **Off** to disable the audio function.

Click the **Factory Reset** button to restore the factory default settings.

Alert Setting

E-Mail Alert

Enable Disable

To:

Cc:

From:

Subject: S320wi-D06486 Alert

SMTP Setting

Out going SMTP Server:

Username:

Password:

Alert Condition

Lamp warning

Low lamp life

Temperature warning

E-mail Alert

- E-mail Alert: You can set whether to be notified by email (Enable) or not (Disable).
- To/Cc/From: You can enter email address of sender (From) and recipients (To/Cc) to receive notification when an abnormality or warning occurs.
- Subject: You can enter the subject line of the email.

Click the **E-mail Alert Test** button to test the e-mail alert settings.

SMTP Setting

- **Out going SMTP server**, **User name**, and **Password** should be provided by your network administrator or MIS.

Alert Condition

- You can select the abnormalities or warnings to be notified by email. When any of the alert conditions occur, an email will be sent to the recipients (To/Cc).

Click the **Save** button to the save settings.



NOTE: E-mail alert is designed to work with a standard SMTP server using the default 25 port. It does not support encryption and authentication (SSL or TLS).

Reboot System

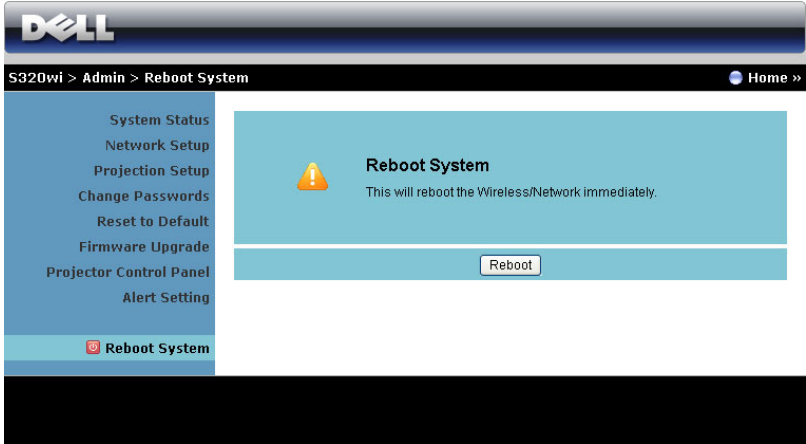

Click **Reboot** to reboot the system.

Crestron

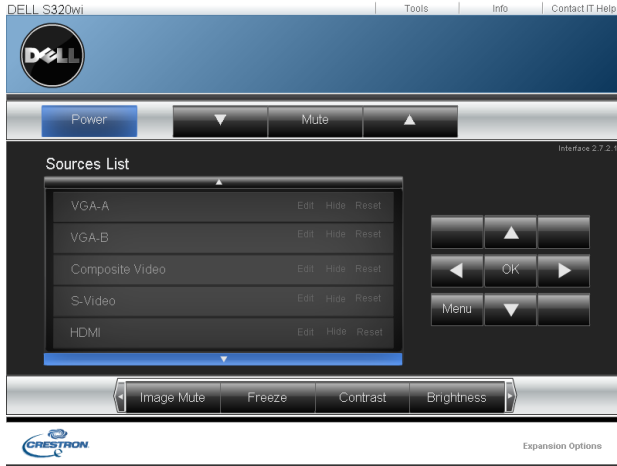

For Crestron function.

Managing the Projector From Web Management (Network RJ45 Kit is Optional for S320)

Configuring the Network Setting

If the projector is connected to a network, you can access the projector using a web browser by configuring the network setting (TCP/IP). When using the network function, the IP address should be unique. For configuring the network setting, refer to "LAN Settings" on page 63.

The RJ45 kit is not shipped with your S320 projector. You can purchase it on the Dell website at www.dell.com. See "Installing the Optional RJ45 Kit" on page 16.

Accessing Web Management

Use Internet Explorer 5.0 and above or Firefox 1.5 and above and enter the IP address. You can now access Web Management and manage the projector from a remote location.

Managing Properties

Home

The screenshot shows the Dell S320 Web Management interface. At the top, there is a blue header with the Dell logo and the text "S320 Web Management". Below the header is a navigation menu on the left with links for Home, Network Setting, Projector Status and Control, E-mail Alert, Password Setting, Firmware Update, and Crestron. The main content area is titled "Home" and contains a welcome message, a "Projector Information" section with details like Model Name, Projector Name, Location, Contact, Status, Lamp Hours, Operation Hours, IP Address, MAC Address, Admin Password, and PPID, and a "Language" section with a dropdown menu set to "English" and a "Submit" button.

DELL™ S320 Web Management

Home

Welcome to DELL S320 Web Management.

Projector Information

Model Name: S320
Projector Name:
Location:
Contact:
Status: Lamp ON
Lamp Hours: 0 hr.
Operation Hours: 1 hr.
IP Address: 192.168.6.150
MAC Address: 00:1E:C9:BA:4E:12
Admin Password: Not Set
PPID: CN-01J1M1-S00081-23K-0001

Language

English

- Access the Web Management Home page by entering the projector's IP address at the web browser. See "LAN Settings" on page 63.
- **Language:** Allows you to set the language for web management.

Network Settings

DELL™ S320 Web Management

Network Settings

Model Name:

Projector Name:

Location:

Contact:

DHCP Manual

IP Address:

Subnet Mask:

Gateway:

DNS Server:

Crestron Control System Device

IP Address:

Device ID:

Port:

- Set up the **Model Name**, **Projector Name**, **Location**, and **Contact** information (up to 21 characters for each field). Press **Save** to store the settings.
- Choose **DHCP** to assign an IP address to the projector from a DHCP server automatically, or **Manual** to assign an IP address manually.
- Set up the **IP Address**, **Device ID**, and **Port** information on the Crestron function.

Projector Status and Control Page

The screenshot shows the Dell S320 Web Management interface. The top navigation bar includes 'Home', 'Network Setting', 'Projector Status and Control', 'E-mail Alert', 'Password Setting', 'Firmware Update', and 'Crestion'. The main content area is titled 'Projector Status and Control' and is divided into three sections:

- Projector Status:** Includes a 'Refresh' button, 'Projector Status' (Lamp ON), 'Power Saving' (120 min.), 'Alert Status' (empty), 'Power ON', 'Power OFF', and 'Clear' buttons.
- Image Control:** Includes 'Projector Mode' (Front Projection-Desktop), 'Source Select' (VGA-A), 'Video Mode' (Presentation Mode), 'Blank screen' (On/Off), 'Aspect Ratio' (Original/4:3/Wide), 'Brightness' (0), 'Contrast' (0), and 'Auto Adjust' buttons.
- Audio Control:** Includes 'Audio Input' (Analog In), 'Volume' (1), 'Speaker' (On/Off), and 'Factory Reset' buttons.

- **Projector Status:** There are 5 status: Lamp On, Standby, Power Saving, Cooling, and Warming up. Click the **Refresh** button to refresh the status and control settings.
- **Power Saving:** Power Saving can be set to Off, 30, 60, 90, or 120 minutes. Refer to page 68.
- **Alert Status:** There are three error status: Lamp warning, Low lamp life, and Temperature warning. Your projector might lock up in protection mode if any of the alerts is activated. To exit protection mode, click the **Clear** to clear the Alert Status before you could Power ON your projector.
- **Projector Mode:** Allows you to select the projector mode, depending on how the projector is mounted. There are four projection modes: Front Projection-Desktop, Front Projection-Wall Mount, Rear Projection-Desktop and Rear Projection-Wall Mount
- **Source Select:** The Source Select menu allows you to select your projector's input source. You can select **VGA-A**, **VGA-B**, **S-Video**, **Composite Video**, **HDMI**, **Wireless Display**, **USB Display**, or **USB Viewer**.
- **Video Mode:** Select a mode to optimize the display image based on how the projector is being used:
 - **Presentation:** Best for presentation slides.

- **Bright:** Maximum brightness and contrast.
- **Movie:** For viewing movie & photo.
- **sRGB:** Provide a more accurate color representation.
- **Custom:** User preferred settings.
- **Blank Screen:** You can select On or Off.
- **Aspect Ratio:** Allows you to select the aspect ratio to adjust how the image appears.
- **Brightness:** Select value to adjust the brightness of the image.
- **Contrast:** Select value to adjust the display contrast.

Click the **Auto Adjust** button to adjust the settings automatically.

- **Audio Input:** Select the input source. Options are: Analog In, HDMI, and Wireless/LAN.
- **Volume:** You can select the value (0~20) for the audio volume
- **Speaker:** You can select On to enable the audio function or select Off to disable the audio function.

Click the **Factory Reset** button to restore the factory default settings.

E-mail Alert

DELL™ S320 Web Management

E-mail Alert

E-mail Alert Enable Disable

TO

CC

From

Subject

SMTP Setting

Out going SMTP server

User name

Password

Alert Condition

Lamp warning

Low lamp life

Temperature warning

- **E-mail Alert:** You can set whether to be notified by email (Enable) or not (Disable).
- **To/Cc/From:** You can enter email address of sender (From) and recipients (To/Cc) to receive notification when an abnormality or warning occurs.
- **Out going SMTP server, User name, and Password** should be provided by your network administrator or MIS.
- **Alert Condition:** You can select the abnormalities or warnings to be notified by email. When any of the alert conditions occur, an email will be sent to the recipients (To/Cc).

Click the Save button to the save settings.

Password Setting

DELL™ S320 Web Management

Password Setting

Please set your password if you enable this feature for first-time. If password is set, you will require to enter with your password upon you connect to the Web Management.

Administrator

Password Enable Disable

New Password

Confirm Password

Set Security For SNMP

Write Community

Use Password Setting to set up an administrator password to access the **Web Management**. When enabling password for the first time, set the password before enabling it. When the password function is enabled, the administrator password will be required for accessing the **Web Management**.

- **New Password:** Enter new password
- **Confirm Password:** Enter password again and submit
- **Write Community:** Set security for SNMP. Enter password and submit.



NOTE: Contact Dell if you forget your administrator password.

Login Page

DELL™ S320 Web Management

Welcome to DELL S320 Web Management.

Administrator Password:

Login

Projector Information

Projector Name:	D19986
IP Address:	192.168.6.150

- **Administrator Password:** Enter the Administrator Password and click Login.

Firmware Upgrade

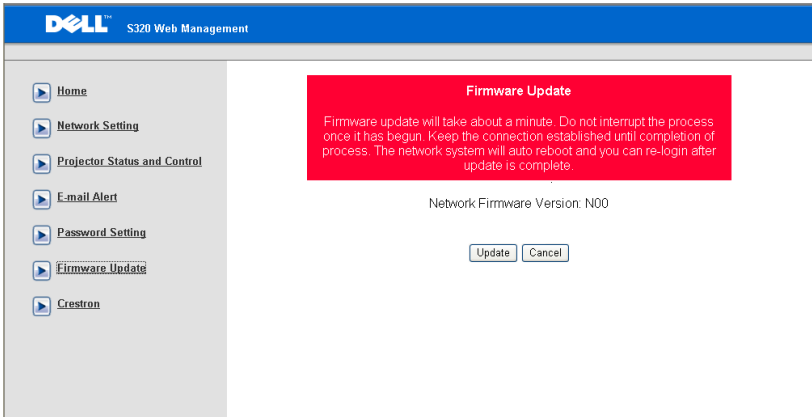

Use the Firmware Update page to update your projector's firmware. Press **Update** to start.

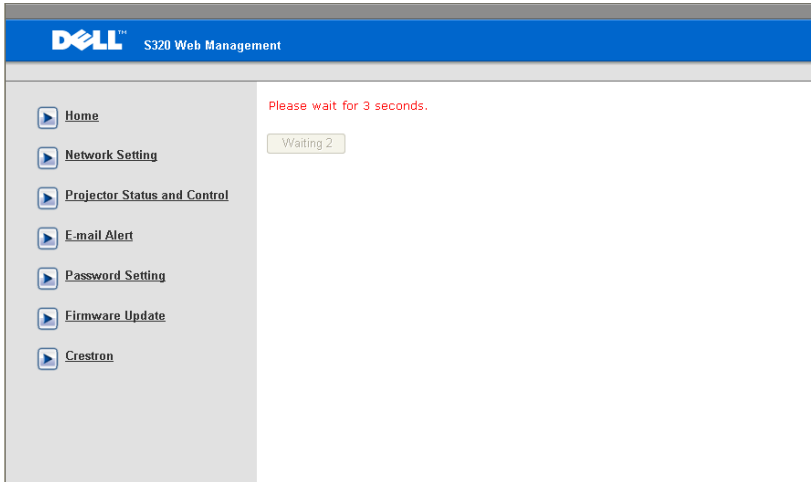

- Please wait till the count reaches 0.

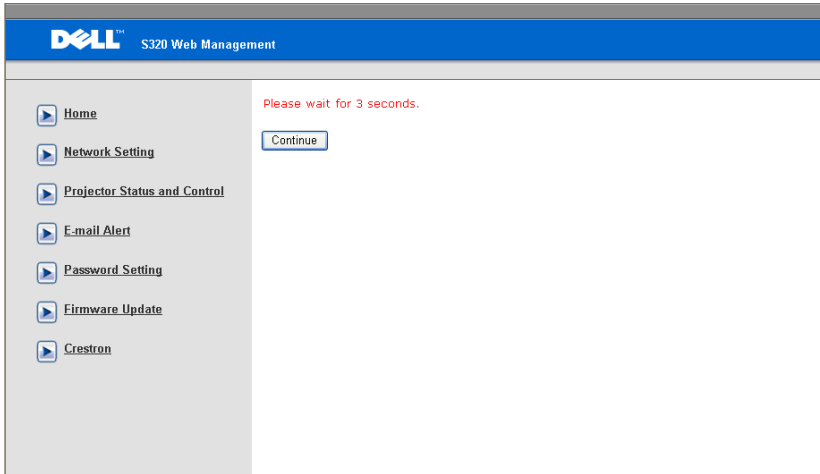

- Wait for 3 seconds and it will proceed to the next step automatically.

Upgrade Firmware

Please select a file (~.bin) to upgrade :

(Upgrading firmware may take 60 seconds)

Upgrade must NOT be interrupted !

- Select the file to upgrade and click the **Upgrade** button. When upgrading is in progress, the **Cancel** button is disabled.

Please wait.
Click on button to proceed after 8 seconds.

Waiting(6)

- Please wait till the count reaches 0.

Please wait.
Click on button to proceed after 8 seconds.

Re Login

- When upgrade is complete, please click the **Re Login** button to go back to the Web Management Home Page.

Crestron

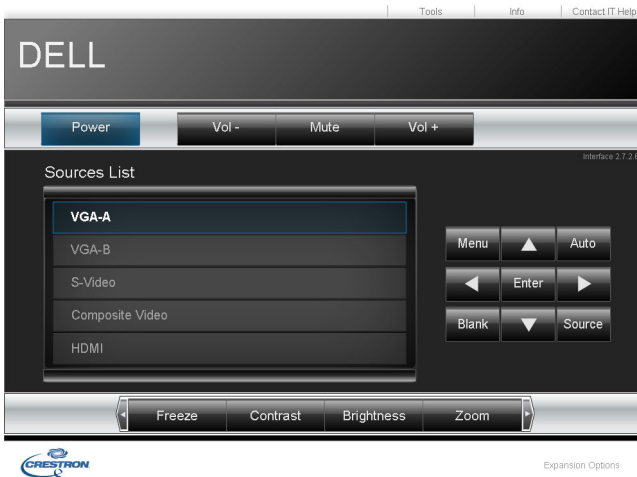

For Crestron function.

FAQS:

I would like to remotely access the projector via the Internet. What is the best setting for the browser?

To have the best setting for the browser, please follow the below steps:

- 1 Open **Control Panel** → **Internet Options** → **General** tab → **Temporary Internet Files** → **Settings** → Select **Every visit to the pages**.
- 2 Some firewall or anti-virus may block the HTTP application. If possible, turn off the firewall or anti-virus.

I would like to remotely access the projector via Internet. What socket port number should I open for it in the firewall?

The following are the TCP/IP socket ports which the projector uses.

UDP/TCP	Port Number	Description
TCP	80	Web configuration (HTTP)
UDP/TCP	25	SMTP: used for email routing between mail servers
UDP/TCP	161	SNMP: Simple Network Management Protocol
UDP	9131	AMX: used for AMX discovery

Why am I unable to access the projector via the Internet?

- 1 Check whether your computer/laptop is connected to the Internet.
 - 2 Check with your MIS or network administrator whether your computer/laptop is in the same subnet.
-

Why am I unable to access the SMTP server?

- 1** Check with your MIS or network administrator whether the SMTP server function is open for the projector and the IP assigned to the projector is allowed to access the SMTP server. The projector's SMTP socket port number is 25, this cannot be changed.
- 2** Check if the outgoing SMTP server, user name, and password are set correctly.
- 3** Some SMTP servers will check whether the mail address of "From" correlates with the "User name" and "Password". For example, you use test@dell.com as the mail address in "From". You should also use test@dell.com account information for the User name and the password to log in the SMTP server.

Why am I unable to receive the test alert email even though the projector already indicates the test mail is already sent?

It could be because the SMTP server recognized the alert mail as a spam mail or because of the SMTP server restriction. Check with your MIS or network administrator for the SMTP server's setting.

Firewall Configuration and FAQ

Q: Why can't I access the Web Management Page?

A: Your computer's firewall configuration may prevent you from accessing the Web Management Web Page. Please refer to the following configuration settings:

Firewall Protection	Configuration
McAfee Security Center	<ol style="list-style-type: none">1 Launch McAfee Security Center (Start > All Programs > McAfee > McAfee Security Center).2 On the personal firewall plus tab, click View the Internet Applications List.3 Find and select Dell S320 or S320wi Projector from the list.4 Right-click on its Permissions column.5 Select Allow Full Access from the pop-up menu.
Norton AntiVirus	<ol style="list-style-type: none">1 Open Norton AntiVirus (Start > All Programs > Norton AntiVirus > Norton AntiVirus).2 Click Options menu, then select Norton AntiVirus.3 On the Status page, select Internet Worm Protection.4 Find and select Dell S320 or S320wi Projector from the list of programs.5 Right-click on its Internet Access column.6 Select Permit All from the pop-up menu.7 Click OK.
Sygate Personal Firewall	<ol style="list-style-type: none">1 Open Sygate Personal Firewall (Start > All Programs > Sygate > Sygate Personal Firewall).2 From the Running Applications list, find and right-click on Dell S320 or S320wi Projector.3 Select Allow from the pop-up menu.

Firewall Protection	Configuration
Windows Firewall	<ol style="list-style-type: none"> 1 Open Windows Firewall (Start > All Programs > Control Panel). Double-click on Windows Firewall. 2 On the General tab, uncheck Don't allow exceptions. 3 On the Exceptions tab, click the Add Program... button. 4 Find and select Dell S320 or S320wi Projector from the list of programs, then click OK. 5 Click OK to confirm exceptions settings.
Zone Alarm	<ol style="list-style-type: none"> 1 Open Zone Alarm Firewall (Start > All Programs > Zone Labs > Zone Labs Center). 2 On the Program Control page, find and select Dell S320 or S320wi Projector from the list. 3 Right-click on its Access-Trusted column. 4 Select Allow from the pop-up menu. 5 Right-click and select Allow for the Access-Internet, Server-Trusted, and Server-Internet columns.

Make Application Token

The Application Token lets you perform Plug and Show using a USB token.

 **NOTE:** This is only application to S320wi or a wireless-enabled S320.

- 1 From the application software, click  > **Make Application Token**.
- 2 The following screen appears. Click **Next**.



- 3 Plug a flash drive into any of the USB ports on your computer. Select the drive from the list, then click **Next**.

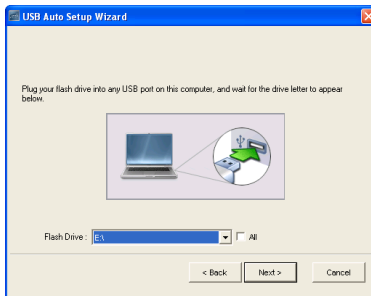

- 4 Click **Finish** to close the wizard.



Troubleshooting Your Projector



If you experience problems with your projector, see the following troubleshooting tips. If the problem persists, contact Dell™ (see *Contacting Dell™* on page 144).



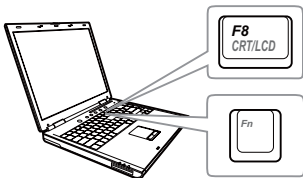

Problem

No image appears on the screen



Possible Solution

- Ensure that you have chosen the correct input source on the INPUT SOURCE menu.
- Ensure the external graphics port is enabled. If you are using a Dell™ laptop computer, press   (Fn+F8). For other computers, see your respective documentation. If images are not displayed properly, please upgrade the video driver of your computer. For Dell computers, see support.dell.com.
- Ensure that all the cables are securely connected. See "Connecting Your Projector" on page 13.
- Ensure that the pins of the connectors are not bent or broken.
- Ensure that the lamp is securely installed (see "Changing the Lamp" on page 134).
- Use **Test Pattern** in the **Projector Settings of the Advanced Settings** menu. Ensure that the colors of the test pattern are correct.

Problem (continued)	Possible Solution (continued)
Partial, scrolling, or incorrectly displayed image	<ol style="list-style-type: none"> 1 Press the Auto Adjust button on the remote control or the control panel. 2 If you are using a Dell™ laptop computer, set the resolution of the computer to WXGA (1280 x 800): <ol style="list-style-type: none"> a Right-click the unused portion of your Microsoft® Windows® desktop, click Properties, and then select Settings tab. b Verify that the setting is 1280 x 800 pixels for the external monitor port. c Press   (Fn+F8). <p>If you experience difficulty in changing resolutions, or if your monitor freezes, restart all the equipment and the projector.</p> <p>If you are not using a Dell™ laptop computer, see your documentation. If images are not displayed properly, please upgrade the video driver of your computer. For a Dell computer, see support.dell.com.</p>
The screen does not display your presentation	If you are using a portable computer, press   (Fn+F8).
Image is unstable or flickering	Adjust the tracking in the OSD Display Settings of the Advanced Settings menu (in PC Mode only).
Image has vertical flickering bar	Adjust the frequency in the OSD Display Settings of the Advanced Settings menu (in PC Mode only).
Image color is incorrect	<ul style="list-style-type: none"> • If the display receives the wrong signal output from the graphics card, please set the signal type to RGB in the OSD Image Settings of the Advanced Settings tab. • Use Test Pattern in the Projector Settings of the Advanced Settings menu. Ensure that the colors of the test pattern are correct.

Problem (continued)	Possible Solution (continued)
Image is out of focus	<ol style="list-style-type: none"> 1 Adjust the focus ring on the projector lens. 2 Ensure that the projection screen is within the required distance from the projector 1.31 ft [0.4 m] to 12.5 ft [3.82 m].
The image is stretched when displaying a 16:9 DVD	<p>The projector automatically detects the input signal format. It will maintain the aspect ratio of the projected image according to input signal format with an Original setting.</p> <p>If the image is still stretched, adjust the aspect ratio in the Display Settings of the Advanced Settings menu in the OSD.</p>
Image is reversed	Select Projector Settings of the Advanced Settings from the OSD and adjust the projector mode.
Lamp is burned out or makes a popping sound	When the lamp reaches its end of life, it may burn out and may make a loud popping sound. If this occurs, the projector does not turn back on. To replace the lamp, see "Changing the Lamp" on page 134.
LAMP light is solid amber	If the LAMP light is solid amber, replace the lamp.
LAMP light is blinking amber	<p>If the LAMP light is blinking amber, the lamp module connection may be disrupted. Please check the lamp module and ensure that it is properly installed.</p> <p>If the LAMP lights and the Power light are blinking amber, the lamp driver has failed and the projector will automatically shut down.</p> <p>If the LAMP and TEMP lights are blinking amber and the Power light is solid blue, the color wheel has failed and the projector will automatically shut down.</p> <p>To clear the protection mode, press and hold the POWER button for 10 seconds.</p>

Problem (continued)	Possible Solution (continued)
TEMP light is solid amber	The projector has overheated. The display automatically shuts down. Turn the display on again after the projector cools down. If the problem persists, contact Dell™.
TEMP light is blinking amber	If the projector fan fails, the projector will automatically shut down. Try to clear the projector mode by pressing and holding the Power button for 10 seconds. Please wait for about 5 minutes and try to power up again. If the problem persists, contact Dell™.
The OSD does not appear on the screen	Try to press the Menu button on the panel for 15 seconds to unlock the OSD. Check the Menu Lock on page 65.
The remote control is not operating smoothly or works only within a limited range	The battery may be low. If so, replace with two new AAA batteries.

Troubleshooting your Interactive Pen

Problem (continued)	Possible Solution (continued)
Cannot use the Pen or cannot connect the Pen	<ul style="list-style-type: none"> • Check if the input source is PC (VGA, HDMI, Wireless and LAN source) • Check if the Interactive function is turned On. (Menu -> Advanced Settings -> Interactive Settings -> Interactive) • Check if the Connection option is set correctly. (Menu -> Advanced Settings -> Interactive Settings -> Connection) • When using Wireless or LAN connection, and the Pen does not work, check if the Wireless and LAN function is turned On. <ol style="list-style-type: none"> 1 Menu -> Advanced Settings -> LAN Settings -> Wireless and LAN 2 Menu -> Advanced Settings -> Wireless Settings -> Wireless • When using Wireless or LAN connection, check if Dell Wireless Application Software is connected. (Only support full screen mode output). • Check if Lens is facing towards the screen. • Push any key to wake up (except Nib button).
The LED does not work.	Check if the battery is depleted.
The Amber LED is continuously lit	The battery is low, charging the Interactive Pen battery.
The Green LED is continuously lit, but the cursor does not move, and the projector screen displays "USB connection is not detected".	Check the mini USB cable connection between your computer and your S320wi projector.
Cannot select Interactive	Check if there is a PC (VGA, HDMI, Wireless and LAN source) input source.

Cannot use the Pen in 3D source.	<ul style="list-style-type: none"> a Supports the VGA and HDMI output signal at 120 Hz only. b Composite/S-Video output signal at 60 Hz and Component output signal are not supported.
Cannot use the Pen in Composite Video or S-Video source.	Composite Video or S-Video source is not supported.
Cannot use Nib	If the Nib is worn out, replace with a new Nib.
When using USB Display, can Wireless USB function be used?	Wireless USB function is not supported.

Guiding Signals

Projector Status	Description	Control Buttons		Indicator	
		Power	TEMP (Amber)	LAMP (Amber)	
Standby mode	Projector in Standby mode. Ready to power on.	BLUE Flashing	OFF	OFF	OFF
Warming up mode	Projector takes some time to warm up and power on.	BLUE	OFF	OFF	OFF
Lamp on	Projector in Normal mode, ready to display an image. Note: The OSD menu is not accessed.	BLUE	OFF	OFF	OFF
Cooling mode	Projector is cooling to shutdown.	BLUE	OFF	OFF	OFF
Cooling before Power Saving mode	The projector takes 60 seconds to cool down before entering Power Saving mode.	AMBER	OFF	OFF	OFF
Projector overheated	Air vents might be blocked or ambient temperature may be above 35 °C. The projector automatically shuts down. Ensure that the air vents are not blocked and that the ambient temperature is within operational range. If the problem persists, contact Dell.	OFF	AMBER	OFF	OFF
Lamp driver overheated	The lamp driver is overheated. The air vents may be blocked. The projector automatically shuts down. Turn the display on again after the projector cools down. If the problem persists, contact Dell.	AMBER	AMBER	OFF	OFF
Fan breakdown	One of the fans has failed. The projector automatically shuts down. If the problem persists, contact Dell.	OFF	AMBER Flashing	OFF	OFF
Lamp driver breakdown	The lamp driver has failed. The projector automatically shuts down. Unplug the power cord after three minutes and then turn the display on again. If this problem persists, contact Dell.	AMBER Flashing	OFF	AMBER Flashing	AMBER Flashing
Color Wheel breakdown	Color wheel cannot start. The projector has failed and the projector automatically shuts down. Unplug the power cord after three minutes and then turn on the projector. If this problem persists, contact Dell.	BLUE	AMBER Flashing	AMBER Flashing	AMBER Flashing
Lamp failure	Lamp is defective. Replace the lamp.	OFF	OFF	AMBER	AMBER
Fault - DC supply (+12V)	Power supply has been interrupted. The projector automatically shuts down. Unplug the power cord after three minutes and then turn on the projector. If this problem persists, contact Dell.	AMBER Flashing	AMBER	AMBER	AMBER
Lamp module connection failed	Lamp module connection may be disrupted. Check the lamp module and ensure that it is properly installed. If the problem persists, contact Dell.	OFF	OFF	AMBER Flashing	AMBER Flashing

Interactive Pen LED Guiding Signals

PEN Status	Description	Indicator		Checking flow and items / times
		Green color	Amber color	
Normal Mode 1	Pen faces the screen with the link.	Solid ON	OFF	
Normal Mode 2	Pen doesn't face the screen but with the link.	Flashing 0.02s ON / 1s OFF	OFF	Will enter Sleep Mode after 3 minutes
Search for Open network mode	When Pen searching for open network (Green LED flashing twice every 2 sec). After holding down Nib and Function button for 5 secs, the pen will change to this mode.	Flashing 0.1s ON / 0.1s OFF & 0.1s ON / 1.7s OFF	OFF	If the pen doesn't pair with projector successfully, the pen will enter Sleep Mode after 3 minutes
Search for Fixed network mode	When Pen searching for fixed network.	Flashing 0.3s ON / 0.3s OFF	OFF	If the pen doesn't pair with projector successfully, the pen will enter Sleep Mode after 3 minutes
Pairing mode	After holding down Function button for 5 secs, the Green LED will blink 1 time each 0.15 secs (continued 10 seconds).	Flashing 0.15s ON / 0.15s OFF	OFF	If the pen pair with projector successfully, the pen will enter Pair successful mode. If the pen doesn't pair with projector successfully, the pen will enter Pair failed mode after 10 seconds.
Pair successful mode	When pen pair with projector successfully after pairing mode (Green and Amber LED will flash alternately continued 3 seconds).	Flashing 0.3s ON / 0.3s OFF	Flashing 0.3s OFF / 0.3s ON	Enter pairing mode and pair successfully in 10 seconds
Pair failed mode	When pen pair with projector failed after pairing mode (Green and Amber LED will flash at the same time continued 3 seconds).	Flashing 0.3s ON / 0.3s OFF	Flashing 0.3s ON / 0.3s OFF	Enter pairing mode and pair failed after 10 seconds
Sleep mode	Enter sleep mode for power saving purpose.	Solid ON 3 sec.	Solid ON 3 sec.	1. Pen doesn't face the screen but with the link: will enter Sleep mode after 3 minutes. 2. After searching for AP channel 3 cycles without a link, will enter Sleep mode.
Low battery capability	The pen battery is low. Two hours are left to run out of the battery.	OFF	Flashing 1s ON / 1s OFF	The MSP430 will check battery capacity in normal operation. This alert LED signal is shown if the battery capacity is low.
Battery is exhausted and can not run PB	The Photo sensor and RF module cannot work properly. Pen can not work normal.	OFF	Solid ON	The pen battery is exhausted. Power only works for MSP430. The alert LED will appear 1 minute to save power and then enter Sleep mode. Pen cannot be used in this status.
Battery charging when battery low	Pen put on the charger or connect USB cable by Laptop	N/A	Solid ON	
Battery charging when battery full	Pen put on the charger or connect USB cable by Laptop	N/A	OFF	

Changing the Lamp

CAUTION: Before you begin any of the procedures in this section, follow the Safety Instructions as described on page 11.

Replace the lamp when the message "**Lamp is approaching the end of its useful life in the operation. Replacement suggested!** www.dell.com/lamps" appears on the screen. If this problem persists after replacing the lamp, contact Dell™. For more information, see Contacting Dell™ on page 144.

CAUTION: Use an original lamp to ensure safe and optimal working condition of your projector.

CAUTION: The lamp becomes very hot when in use. Do not attempt to replace the lamp until the projector has been allowed to cool down for at least 30 minutes.

CAUTION: Do not touch the bulb or the lamp glass at any time. Projector lamps are very fragile and may shatter if touched. The shattered glass pieces are sharp and can cause injury.

CAUTION: If the lamp shatters, remove all broken pieces from the projector and dispose or recycle according to state, local, or federal law. For more information see www.dell.com/hg.

- 1 Turn off the projector and disconnect the power cord.
- 2 Let the projector cool for at least 30 minutes.
- 3 Loosen the two screws that secure the lamp cover, and remove the cover.
- 4 Loosen the two screws that secure the lamp.
- 5 Pull the lamp up by its metal handle.

NOTE: Dell™ may require lamps replaced under warranty to be returned to Dell™. Otherwise, contact your local waste disposal agency for the address of the nearest deposit site.

- 6 Replace with the new lamp.
- 7 Tighten the two screws that secure the lamp.
- 8 Replace the lamp cover and tighten the two screws.

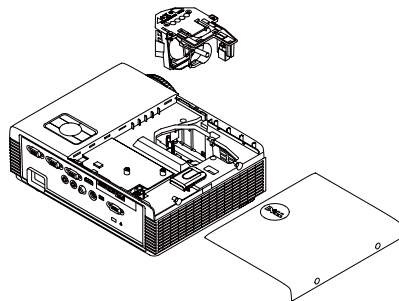

9 Reset the lamp usage time by selecting "Yes" for **Lamp Reset** in the OSD **Power Settings of the Advanced Setting menu** (see Power Settings of the Advanced Setting menu on page 67). When a new lamp module has been changed, the projector will automatically detect and reset the lamp hours.



CAUTION: Lamp Disposal (for the US only)



LAMP(S) INSIDE THIS PRODUCT CONTAIN MERCURY AND MUST BE RECYCLED OR DISPOSED OF ACCORDING TO LOCAL, STATE, OR FEDERAL LAWS. FOR MORE INFORMATION, GO TO WWW.DELL.COM/HG OR CONTACT THE ELECTRONIC INDUSTRIES ALLIANCE AT WWW.EIAE.ORG. FOR LAMP-SPECIFIC DISPOSAL INFORMATION, CHECK WWW.LAMPRECYCLE.ORG.

Specifications

Light Valve	0.55" XGA S450 DMD, DarkChip3™
Brightness	3000 ANSI Lumens (Max.)
Contrast Ratio	2200:1 Typical (Full On/Full Off)
Uniformity	80% Typical (Japan Standard - JBMA)
Number of Pixels	1024 x 768 (XGA)
Aspect Ratio	4:3
Displayable Color	1.07 billion colors
Color Wheel Speed	2 X 1 X for 3D Display
Projection Lens	F-Stop: F/2.8 Effective Focal length=7.26 mm Fixed Lens, Digital Zoom only Throw ratio =0.626 wide and tele
Offset Ratio	115±5%
Projection Screen Size	31.45 ~ 300 inches (diagonal)
Projection Distance	1.31 ft ~ 12.5 ft (0.4 m ~ 3.82 m)
Video Compatibility	Composite Video / S-Video: NTSC (J, M, 4.43), PAL (B, D, G, H, I, M, N), SECAM (B, D, G, K, K1, L) Component Video input via VGA: 1080i, 720p, 576i/p, 480i/p HDMI input: 1080p, 720p, 576i/p, 480i/p
Power Supply	Universal AC 100-240 V 50-60 Hz with PFC input

Power Consumption

Normal mode: 305 W \pm 10% @ 110 Vac
Eco mode: 225 W \pm 10% @ 110 Vac
Power saving mode: <15 W (Wireless and Network On)
Standby mode: < 0.5 W (Network Off, and VGA_OUT Off, and Wireless Off)

Audio

1 speaker x 5 watt RMS

Noise Level

35 dB(A) Normal mode, 31 dB(A) Eco mode

Projector Weight

7 lb (3.18 kg)

Interactive Pen Weight

0.13 lb (60 g) (with Li-ion battery)

Projector Dimensions
(W x H x D)

11.3 x 3.6 x 8.7 inches (288 x 92 x 220 mm)

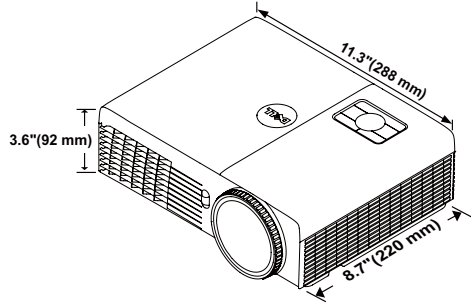

Interactive Pen Dimensions
(W x H x D)
for S320wi only

0.88 x 0.94 x 6.66 inches (22.46 x 23.79 x 169.17 mm)

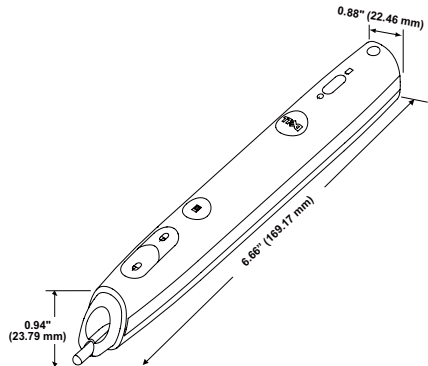

Environmental

Operating temperature: 5 °C - 35 °C (41 °F- 95 °F)
Humidity: 80% maximum

Storage temperature: 0 °C to 60 °C (32 °F to 140 °F)
Humidity: 90% maximum

Shipping temperature: -20 °C to 60 °C
(-4 °F to 140 °F)
Humidity: 90% maximum

I/O Connectors (for S320/S320wi)

Power: One AC power socket (3-pin - C14 inlet)

VGA input: Two 15-pin D-sub connectors (Blue), VGA-A and VGA-B, for analog RGB/Component input signals.

VGA output: One 15-pin D-sub connector (Black) for VGA-A loop through.

S-Video input: One standard 4-pin min-DIN S-Video connector for Y/C signal.

Composite Video input: One Yellow RCA jack for CVBS signal.

HDMI input: One HDMI connector for supporting HDMI 1.3. HDCP compliant.

Analog Audio input: One 3.5 mm stereo mini phone jack (Blue).

Variable audio output: One 3.5 mm stereo mini phone jack (Green).

USB (type B) port: One mini USB slave for remote support and Interactive Pen.

RS232 port: One 9-pin D-sub for RS232 communication.

USB (type A) port (embedded for S320wi): One USB connector for Photo/PtG viewer (JPG/PPT format).

USB (type B) port (embedded for S320wi): One USB connector for supporting USB display.

RJ45 port (embedded for S320wi): One RJ45 connector for control of projector through network and LAN display.

Wireless Dongle
(embedded for S320wi)

Wireless Standard: IEEE802.11b/g/n

Wireless: One WiFi USB (type A) connector for supporting wireless dongle (Embedded WiFi, USB interface).

OS environment: Windows 7/Vista/XP/2000, MAC OS X

Support: Presentation slides and projector control.

Allow connection up to 30 users at the same time.

4-to-1 split screen. Allows four presentation slides to be projected on screen.

Conference Control mode.

Supports Audio Projection (driver installation may be required. Download from support.dell.com).

Lamp

Philips 240 W user-replaceable lamp

Lamp life

Without image care

Normal mode: Up to 3000 hours

ECO mode: Up to 4000 hours

With image care

Normal mode: Up to 4000 hours

ECO mode: Up to 5000 hours



NOTE: The lamp life rating for any projector is a measure of brightness degradation only, and is not a specification for the time it takes a lamp to fail and cease light output. Lamp life is defined as the time it takes for more than 50 percent of a lamp sample population to have brightness decrease by approximately 50 percent of the rated lumens for the specified lamp. The lamp life rating is not guaranteed in any way. The actual operating life span of a projector lamp will vary according to operating conditions and usage patterns. Usage of a projector in stressful conditions which may include dusty environments, under high temperatures, many hours per day, and abrupt powering-off will most likely result in a lamp's shortened operating life span or possible lamp failure.



NOTE: All optical performance is measured under the condition of the Interactive Pen off within user manual or product specification.

RS232 Pin Assignment

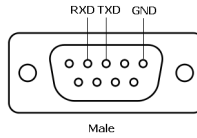

RS232 Protocol

- Communication Settings

Connection settings	Value
Baud Rate	19,200
Data Bits	8
Parity	None
Stop Bits	1

- Command types

To pop up the OSD menu and adjust the settings.

- Control command Syntax (From PC to Projector)

[H][AC][SoP][CRC][ID][SoM][COMMAND]

- **Example:** Power ON Command (Send low byte firstly)

--> 0xBE, 0xEF, 0x10, 0x05, 0x00, 0xC6, 0xFF, 0x11, 0x11, 0x01, 0x00, 0x01

- Control Commands List

To view the latest RS232 code, go to the Dell Support site at support.dell.com.

To view the latest SNMP commands and list, go to the Dell Support site at support.dell.com.

Compatibility Modes (Analog/Digital)

Resolution	Refresh Rate (Hz)	Hsync Frequency (KHz)	Pixel Clock (MHz)
640 x 350	70.087	31.469	25.175
640 x 480	59.940	31.469	25.175
640 x 480 p60	59.940	31.469	25.175
720 x 480 p60	59.940	31.469	27.000
720 x 576 p50	50.000	31.250	27.000
720 x 400	70.087	31.469	28.322
640 x 480	75.000	37.500	31.500
848 x 480	60.000	31.020	33.750
640 x 480	85.008	43.269	36.000
800 x 600	60.317	37.879	40.000
800 x 600	75.000	46.875	49.500
800 x 600	85.061	53.674	56.250
1024 x 768	60.004	48.363	65.000
1280 x 720 p50	50.000	37.500	74.250
1280 x 720 p60	60.000	45.000	74.250
1920 x 1080 i50	50.000	28.125	74.250
1920 x 1080 i60	60.000	33.750	74.250
1280 x 720	59.855	44.772	74.500
1024 x 768	75.029	60.023	78.750
1280 x 800	59.810	49.702	83.500
1366 x 768	59.790	47.712	85.500
1360 x 768	60.015	47.712	85.500
1024 x 768	84.997	68.677	94.500
1440 x 900	59.887	55.935	106.500
1152 x 864	75.000	67.500	108.000
1280 x 960	60.000	60.000	108.000
1280 x 1024	60.020	63.981	108.000
1152 x 864	85.000	77.095	119.651
1400 x 1050	59.978	65.317	121.750
1280 X 800	84.880	71.554	122.500
1280 x 1024	75.025	79.976	135.000
1440 X 900	74.984	70.635	136.750
1680 x 1050	59.954	65.290	146.250
1280 x 960	85.002	85.938	148.500
1920 x 1080	60.000	67.500	148.500
1400 X 1050	74.867	82.278	156.000
1280 x 1024	85.024	91.146	157.000
1440 X 900	84.842	80.430	157.000
1600 x 1200	60.000	75.000	162.000

800 x 600	119.972	76.302	73.250
1024 x 768	119.989	97.551	115.500
1280 x 720	120.000	101.563	146.250



NOTE: The refresh rate of the timings at 120 Hz (gray area) can supported in 3D mode.

Contacting Dell

For customers in the United States, call 800-WWW-DELL (800-999-3355).



NOTE: If you do not have an active Internet connection, you can find contact information on your purchase invoice, packing slip, bill, or Dell product catalog.

Dell™ provides several online and telephone-based support and service options. Availability varies by country and product, and some services may not be available in your area. To contact Dell for sales, technical support, or customer service issues:

- 1 Visit Support.dell.com.
- 2 Verify your country or region in the **Choose A Country/Region** drop-down menu at the bottom of the page.
- 3 Click **Contact Us** on the left side of the page.
- 4 Select the appropriate service or support link based on your need.
- 5 Choose the method of contacting Dell that is convenient for you.

Contacting eInstruction

eInstruction provides phone based and online technical support options. Availability varies by country, but an e-mail to techsupport@einstruction.com can be directed appropriately for users in any country.

USA eInstruction Software Technical Support

Phone: 480-443-2214 or 800-856-0732

Email: Techsupport@einstruction.com

International eInstruction Software Technical Support, EMEA

Phone: +33 1 58 31 1065

Email: EU.Support@einstruction.com

Web-based Technical Support is available at:

www.einstruction.com (in US)

www.einstruction.de (in Germany)

www.einstruction.fr (in France)

www.einstruction.it (in Italy)

www.einstruction.es (in Spain)

Contacting Crestron

Crestron provides phone based and online technical support options. Availability varies by country, but an e-mail to getroomview@crestron.com can be directed appropriately for users in any country.

Technical Support

In the US and Canada

Phone: 877-516-5394

Email: roomviewsupport@crestron.com

Outside the US and Canada

Phone: +1 201-367-1037

Email: roomviewsupport@crestron.com

Appendix: Glossary

ANSI Lumens — A standard for measuring the brightness. It is calculated by dividing a square meter image into nine equal rectangles, measuring the lux (or brightness) reading at the center of each rectangle, and averaging these nine points.

Aspect Ratio — The most popular aspect ratio is 4:3 (4 by 3). Early television and computer video formats are in a 4:3 aspect ratio, which means that the width of the image is 4/3 times the height.

Brightness — The amount of light emitted from a display or projection display or projection device. The brightness of projector is measured by ANSI lumens.

Color Temperature — The color appearance of white light. Low color temperature implies warmer (more yellow/red) light while high color temperature implies a colder (more blue) light. The standard unit for color temperature is Kelvin (K).

Component Video — A method of delivering quality video in a format that consists of the luminance signal and two separate chrominance signals and are defined as 'Y'Pb'Pr' for analog component and 'Y'Cb'Cr' for digital component. Component video is available on DVD players.

Composite Video — A video signal that combines the luma (brightness), chroma (color), burst (color reference), and sync (horizontal and vertical synchronizing signals) into a signal waveform carried on a single wire pair. There are three kinds of formats, namely, NTSC, PAL, and SECAM.

Compressed Resolution — If the input images are of higher resolution than the native resolution of the projector, the resulting image will be scaled to fit the native resolution of the projector. The nature of compression in a digital device means that some image content is lost.

Contrast Ratio — Range of light and dark values in a picture, or the ratio between their maximum and minimum values. There are two methods used by the projection industry to measure the ratio:

- 1 *Full On/Off* — measures the ratio of the light output of an all white image (full on) and the light output of an all black (full off) image.
- 2 *ANSI* — measures a pattern of 16 alternating black and white rectangles. The average light output from the white rectangles is divided by the average light output of the black rectangles to determine the *ANSI* contrast ratio.

Full On/Off contrast is always a larger number than *ANSI* contrast for the same projector.

dB — decibel — A unit used to express relative difference in power or intensity, usually between two acoustic or electric signals, equal to ten times the common logarithm of the ratio of the two levels.

Diagonal Screen — A method of measuring the size of a screen or a projected image. It measures from one corner to the opposite corner. A 9 FT high, 12 FT wide, screen has a diagonal of 15 FT. This document assumes that the diagonal dimensions are for the traditional 4:3 ratio of a computer image as per the example above.

DHCP — Dynamic Host Configuration Protocol — A network protocol that enables a server to automatically assign a TCP/IP address to a device.

DLP® — Digital Light Processing™ — Reflective display technology developed by Texas Instruments, using small manipulated mirrors. Light passing through a color filter is sent to the DLP mirrors which arrange the RGB colors into a picture projected onto screen, also known as DMD.

DMD — Digital Micro-Mirror Device — Each DMD consists of thousands of tilting, microscopic aluminum alloy mirrors mounted on a hidden yoke.

DNS — Domain Name System — An Internet service that translates domain names into IP addresses.

Focal Length — The distance from the surface of a lens to its focal point.

Frequency — It is the rate of repetition in cycles per seconds of electrical signals. Measured in Hz (Hertz).

HDCP — High-Bandwidth Digital-Content Protection — A specification developed by Intel™ Corporation to protect digital entertainment across digital interface, such as DVI, HDMI.

HDMI — High-Definition Multimedia Interface — HDMI carries both uncompressed high definition video along with digital audio and device control data in a single connector.

Hz (Hertz) — Unit of frequency.

IEEE802.11 — A set of standards for wireless local are network (WLAN) communication. 802.11b/g/n uses the 2.4 GHz band.

Keystone Correction — Device that will correct an image of the distortion (usually a wide-top narrow-bottom effect) of a projected image caused by improper projector to screen angle.

Maximum Distance — The distance from a screen the projector can be to cast an image that is usable (bright enough) in a fully darkened room.

Maximum Image Size — The largest image a projector can throw in a darkened room. This is usually limited by focal range of the optics.

Minimum Distance — The closest position that a projector can focus an image onto a screen.

NTSC — National Television Standards Committee. North American standard for video and broadcasting, with a video format of 525 lines at 30 frames per second.

PAL — Phase Alternating Line. A European broadcast standard for video and broadcasting, with a video format of 625 lines at 25 frames per second.

Reverse Image — Feature that allows you to flip the image horizontally. When used in a normal forward projection environment text, graphics, etc. are backwards. Reverse image is used for rear projection.

RGB — Red, Green, Blue — typically used to describe a monitor that requires separate signals for each of the three colors.

S-Video — A video transmission standard that uses a 4-pin mini-DIN connector to send video information on two signal wires called luminance (brightness, Y) and chrominance (color, C). S-Video is also referred to as Y/C.

SECAM — A French and international broadcast standard for video and broadcasting, closely related to PAL but with a different method of sending color information.

SSID — Service Set Identifiers — A name used to identify the particular wireless LAN to which a user wants to connect.

SVGA — Super Video Graphics Array — 800 x 600 pixels count.

SXGA — Super Extended Graphics Array, — 1280 x 1024 pixels count.

UXGA — Ultra Extended Graphics Array — 1600 x 1200 pixels count.

VGA — Video Graphics Array — 640 x 480 pixels count.

WEP — Wired Equivalent Privacy — This is a method for encrypting communication data. The encryption key is created and notified only to the communicating user, so the communication data cannot be decrypted by a third party.

XGA — Extended Video Graphics Array — 1024 x 768 pixels count.

WXGA — Wide Extended Graphics Array — 1280 x 800 pixels count.

Index

A

- Adjusting the Projected Image 31
 - Adjusting the Projector Height 31
 - lower the projector
 - Tilt adjustment wheel 31
- Adjusting the Projector Focus 32
 - Focus ring 32

C

- Changing the Lamp 134
- Connecting the Projector
 - Composite Video cable 23
 - Connecting a Computer with a RS232 cable 19, 20
 - Connecting with a Component Cable 24
 - Connecting with a Composite Cable 23
 - Connecting with an HDMI Cable 25
 - Connecting with an S-video Cable 22
 - HDMI cable 25, 26, 27
 - Power cord 17, 18, 19, 20, 22, 23, 24, 25, 26, 27
 - RS232 cable 19
 - S-Video cable 22
 - To Computer 17
 - USB to USB cable 17
 - USB-A to USB-B cable 20
 - VGA to VGA cable 17, 18
 - VGA to YPbPr cable 24
- Connecting with your Interactive Pen
 - Interactive Pen 28
 - Power cord 28
 - Projection Screen 28
 - USB-A to Mini USB-B Cable 28
 - VGA to VGA Cable 28
- Connection Ports
 - Audio-B left-channel input connector 13
 - Audio-B right-channel input connector 13
 - Composite Video connector 13
 - HDMI connector 13
 - Mini USB for remote mouse, Interactive function and Firmware upgrade. 13
 - RJ45 connector 13
 - RS232 connector 13
 - Security cable slot 13
 - S-Video connector 13
 - USB Type A Viewer connector 13
 - USB Type B Display connector 13
 - VGA-A input (D-sub) connector 13
 - VGA-A output (monitor loop-through) 13
 - VGA-B input (D-sub) connector

13

Contact Dell 7, 129, 134

Control Panel 35

D

Dell

contacting 144

I

Interactive Pen

Control panel 11

Firmware upgrade connector 11

LED indicators 11

Mini USB charge connector 11

Photo sensor 11

Power switch 11

Replaceable nib 11

Wrist strap holder 11

M

Main Unit 10

5W speaker 10

Control panel 10

Focus tab 10

IR receivers 10

Lens 10

Lens cap 10

Lens cover 10

Tilt adjustment wheel 10

O

On-Screen Display 51

ADVANCED SETTINGS 55

AUDIO INPUT 54

AUTO ADJUST 52

BRIGHTNESS/CONTRAST 53

HELP 73

INPUT SOURCE 51

INPUT SOURCE MULTIPLE
DISPLAY 52

LANGUAGE 72

Main Menu 51

VIDEO MODE 53

VOLUME 54

P

phone numbers 144

Powering On/Off the Projector

Powering Off the Projector 30

Powering On the Projector 30

R

Remote Control 37

IR receiver 36

S

Specifications

Audio 137

Brightness 136

Color Wheel Speed 136

Contrast Ratio 136

Dimensions 137

- Displayable Color 136
- Environmental 138
- I/O Connectors 138
- Light Valve 136
- Noise Level 137
- Number of Pixels 136
- Power Consumption 137
- Power Supply 136
- Projection Distance 136
- Projection Lens 136
- Projection Screen Size 136
- RS232 Protocol 141
- Uniformity 136
- Video Compatibility 136
- Weight 137

support

- contacting Dell 144

T

telephone numbers 144

Troubleshooting 126

- Contact Dell 126